

# MEKA

CONCRETE PLANTS







# CONTENT

|                            |           |
|----------------------------|-----------|
| HISTORIC MILESTONES        | <b>4</b>  |
| MEKA TODAY                 | <b>6</b>  |
| GLOBAL PRESENCE            | <b>8</b>  |
| WHY MEKA                   | <b>10</b> |
| PRODUCTS                   | <b>22</b> |
| COMPACT CONCRETE PLANTS    | <b>24</b> |
| MOBILE CONCRETE PLANTS     | <b>36</b> |
| STATIONARY CONCRETE PLANTS | <b>52</b> |
| AUTOMATION                 | <b>70</b> |
| SEA FREIGHT                | <b>74</b> |
| CONCRETE MIXERS            | <b>78</b> |
| OPTIONAL EQUIPMENT         | <b>86</b> |
| ADDITIONAL OPTIONS         | <b>96</b> |



# HISTORIC MILESTONES



## Establishment

First Factory installation in OSTIM (Middle East Organized Industry Zone) Steel Construction manufacturing

1987

Manufacturing of lifting equipment: Cranes and Elevators

1990

1991

Start of concrete machinery manufacturing. Stationary concrete batching plants.

First concrete batching plant exported. Worldwide presence 1 country

1994

2000

MEKA Temelli 1 Factory Established - The first modern facility in Ankara

2003

First mobile concrete batch plant manufactured and exported. Worldwide presence 23 countries

2004

MEKA Eskisehir Factory Established. Annual capacity exceeds 200 concrete plants

2009

High capacity concrete plant installed in London for Heathrow Airport

2012

Start of Crushing and Screening Design and Manufacturing

2014

MEKA Temelli 2 Factory Established. Modern and technological factory for Crushing & Screening Equipment

2016

More than 1500 concrete plants in more than 60 countries



MEKA TODAY

# MEKA is the Choice of Professionals

*MEKA is a Leading Professional Enterprise established in 1987 and focused on manufacturing of Concrete Plants and Crushing & Screening Equipment.*

Being the biggest Turkish manufacturer, we provide a complete scope of services such as identifying customer's needs, project planning, design, engineering, manufacturing, quality control, commissioning, personnel training and after-sales support.

MEKA is committed to the principle of perfection in all of the products and services that it presents to its customers. Providing the information before sales, conducting a need analysis and aftersales support is MEKA the reliable partner for its customers.

We manufacture Crushing and Screening Units – Jaw, Primary/Secondary/Tertiary Impact, Vertical Shaft, Cone and Crushers on Mobile Chassis along with Feeders, Screens and Aggregate Washing Systems. Turnkey solutions can be offered for different types of rocks with different capacities.

We manufacture Concrete Plants – Stationary, Mobile, Compact, Container Type, Plants for Road Concrete, RCC and Precast Applications along with Recycling Systems and Fiber Dosing Equipment. Unique solutions can be designed according to the customers' needs.

**THE CHOICE OF PROFESSIONALS**  
MEKA is taking firm steps forward as a significant player in the sector with annual 250 concrete plants production capacity, 330 personnel, 40 engineers and 4 modern facilities with total area of 75.000 m<sup>2</sup> (at Ostim/Ankara - 1.500 m<sup>2</sup>, 1st Temelli/ Ankara - 18.000 m<sup>2</sup>, 2nd Temelli/ Ankara - 23.500 m<sup>2</sup>, Eskisehir - 32.000 m<sup>2</sup>) equipped with advanced machinery and technology.

We have been supplying our equipment to more than 60 countries for the world's biggest contractors, cement manufacturers and ready-mix giants.

MEKA is a Choice of Many Professionals and a reliable partner you can trust. We do not only offer standard equipment, we deliver cost-effective solutions to different civil engineering projects worldwide no matter how complex they are.

Each MEKA Concrete Plant or a Crushing & Screening Unit is the result of nearly 30 years of full dedication. There is therefore knowledge and care in every detail.

**MEKA is the Choice of Professionals**





# GLOBAL PRESENCE

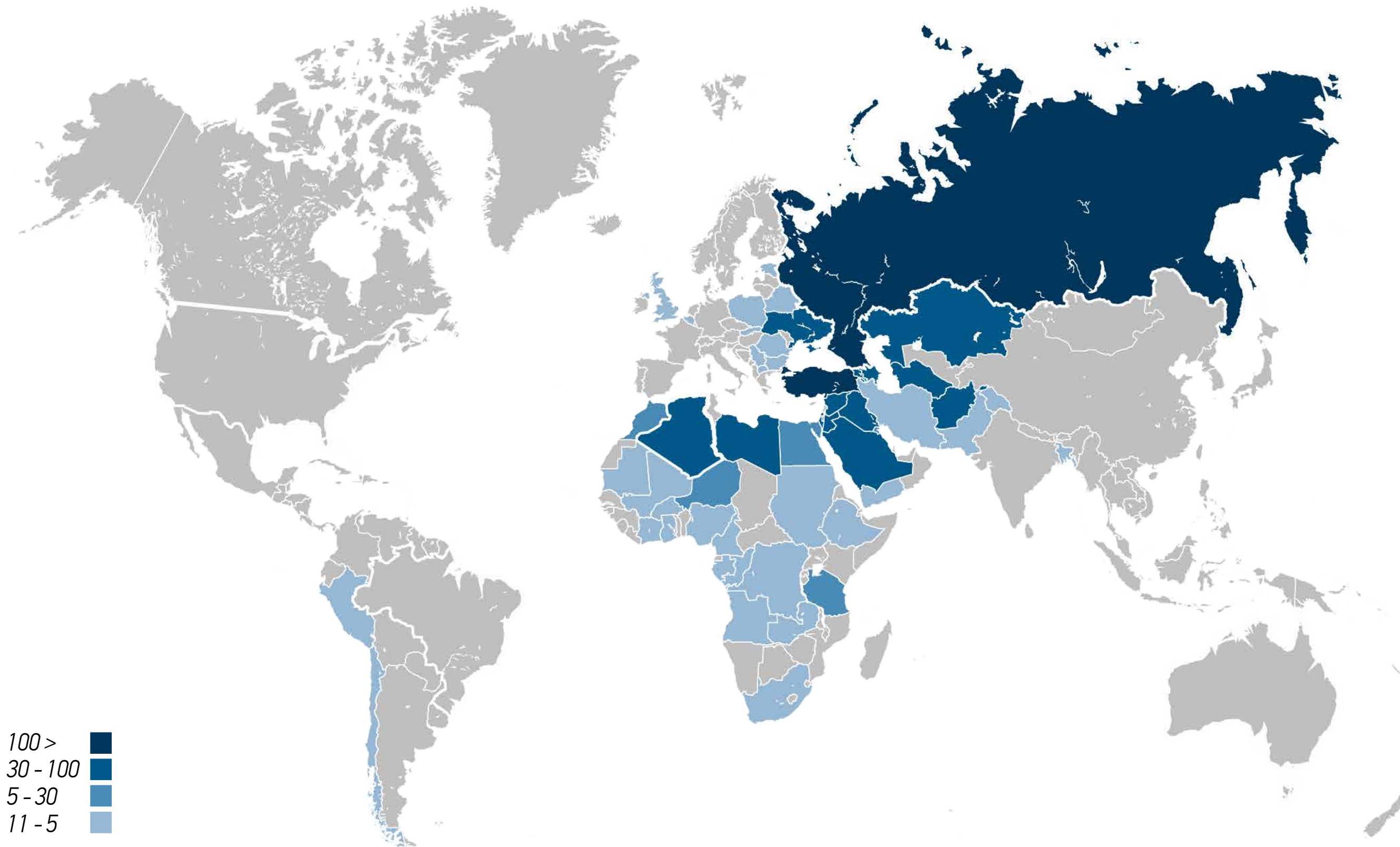

100 >   
 30 - 100   
 5 - 30   
 11 - 5

- |  |  |  |
|--|--|--|
|  |  |  |
|  |  |  |
|  |  |  |
|  |  |  |
|  |  |  |
|  |  |  |
|  |  |  |
|  |  |  |
|  |  |  |
|  |  |  |
|  |  |  |



# WHY MEKA



- ▶ Professional Enterprise with almost 30 years of experience
- ▶ Full scope of services: identifying customer's needs, project planning, design, engineering, manufacturing, quality control, commissioning, personnel training and after-sales support.
- ▶ Affordable cost effective high quality equipment
- ▶ Only high quality components
- ▶ Strong well-known companies among references in local market
- ▶ Flexibility in design and manufacturing
- ▶ "Quality is a Culture" policy



WHY MEKA

# One of the main aspects of MEKA's High Quality

*MEKA has been developing its Engineering Team for nearly 30 years in order to invent, innovate, design and keep up with the latest technology.*

Our products changed and improved a lot since the first concrete plant and mixer has been shipped from our small factory many years ago. Variety of models were invented to meet the requirements of fast developing construction sector.

MEKA gains trust with confidence and guides its customers to the best engineering solutions it can offer. There is knowledge and care in every detail.

Today we are a "Solution Partner" for many sector professionals attracting large scale of interest with our customized solutions for very important projects of infrastructure worldwide. People believe in MEKA and count on us as the project completion is directly connected to the equipment. Our Flexibility and Success would not be possible without Perfect Engineering.

Every idea transformed into lines we draw on paper is a result of deep analysis and strict calculations. Advanced software allows us to test equipment even before the first profile is cut in our manufacturing facilities. It results in overall high quality about any product we manufacture.



PERFECT  
ENGINEERING



# MEKA's Manufacturing Facilities – Where ideas come to life

*MEKA has always been investing in its factories and labor resources to increase the safety of the personnel, to increase the quality and production capacity, to evaluate new products and to manufacture customized designs to meet the uncountable requests from the market.*

Back in 1987 there were just a few technicians working on an area of a couple of hundreds of square meters. But those people together with the management have dedicated themselves to MEKA and created a vision that was taking them forward. Some of them are still with MEKA proving that their vision was right.

Today MEKA is taking firm steps forward as a significant player in the sector with 330 personnel, 40 engineers and 4 modern facilities with total area of 75.000 m<sup>2</sup> (at Ostim/Ankara - 1.500 m<sup>2</sup>, 1st Temelli/Ankara - 18.000 m<sup>2</sup>, 2nd Temelli/Ankara - 23.500 m<sup>2</sup>, Eskisehir - 32.000 m<sup>2</sup>) equipped with advanced machinery and technology. Annual improvement reflects to each of our products making them better, more competitive, unique, robust and reliable.

Investment in advanced machinery was inevitable for continuous improvement and new product line development, like Crushing and Screening Units. Today along with Concrete Plants we manufacture a variety of Crushers – Jaw, Primary/

Secondary/Tertiary Impact, Vertical Shaft, Cone and Crushers on Mobile Chassis along with Feeders, Screens and Aggregate Washing Systems. Turnkey solutions can be offered for different types of rocks with different capacities. In order to do it we had to establish a new factory to improve our machinery and labor.

Starting from the very beginning quality has always been a priority not only for the management but for all the involved personnel. Quality is a culture in MEKA and this awareness spreads in all of its departments.



TECHNOLOGICAL  
MANUFACTURING





# PREMIUM QUALITY PARTS



WHY MEKA

## MEKA Quality is Hidden in the Details

*The quality of the final product is determined by many aspects, components and processes.*

Reaching high quality by improving only one side of the product is not possible as the chain is as strong as its weakest link. Small components and parts are playing an important role and require correct selection and strict entry control.

Keeping it in mind, MEKA has never compromised the quality of the parts and its subcontractors and has developed strong relations with the best well-known and reliable component suppliers. We offer only premium parts with our concrete batch plants and crushing and screening equipment. This ensures long-term reliable continuous operation with minimum possibilities of break-downs.

The equipment that we offer is an investment, it is a tool and not a final product in the long chain of construction process. So being a link of another chain, a concrete batch plant or a crushing and screening unit has to be chosen properly to support the whole process.

Meeting the expectations of many professionals worldwide MEKA offers only high quality components and parts. There is knowledge and care in every detail.





# MEKA – Built to Last

*Durability is not just another aspect of MEKA Quality, but a philosophy of manufacturing coming from the very beginning of MEKA.*

Highly experienced engineers, technicians and welders in the sector care about your results and therefore calculate, design and create the best equipment for any condition you can face with. MEKA has proven to be extremely reliable in hard nature conditions, extreme temperatures, long continuous operation, high dynamic stress and heavy loads.

Project completion and the operation of the whole chain of supply is directly connected to the Concrete Plant. It might not be the highest value in total amount of the investment but it is definitely the most important

one. Durable and reliable operation with minimum break downs guarantees faster construction with minimum defects, higher profits, minimum time loss and positive image of the company possessing such equipment. We care about our customer's results and never compromise the operation characteristics.

MEKA is a solution partner for many sector professionals worldwide.



DURABLE  
EQUIPMENT





# Sales go Up and Down Service stays Forever

*Investment products require almost immediate support since company's success, profit and sometimes future are directly connected to equipment the company invested in.*

Our experienced Service team is here to support you no matter where you are located. Around 40 supervisors are ready to be on your site within the shortest possible time. Wide spare part stocks and trained personnel in many locations worldwide will ensure you get the fastest support for your equipment.

*is being provided both from the main office and local affiliates.*

***Without service even the most advanced technology is useless***

#### **Wide Aftersales Network**

*The number of local agents and offices is increasing each day. We are trying to be closer to all our customers and today you can get immediate support in more than 20 countries. Free online and phone support*

SERVICE  
**STAYS**  
FOREVER







# PRODUCTS



# Compact Concrete Plants

*The MEKA range of compact concrete batching plants are designed for quick and easy erection and simple transportation.*

All MEKA compact concrete plants are designed and built to the highest standards, using only superior quality materials and components, to provide a robust and semi mobile solution for all your concrete production requirements. Some of our compact models are designed to fit into 40FT OT containers and some parts are partially container itself.

We are continuously developing in order to provide the most convenient, economical and easy to transport solutions for temporary needs. On the other hand, we take care about our customers' installation expenses and offer solutions to lower civil works on site with our steel frame foundations for main structures and silos.



COMPACT  
CONCRETE  
PLANTS



# C20 - Small but Capable

Hasanlar Dam in Turkey was constructed with the help of a single C20 concrete plant. Topaktaş Construction has chosen C20 for a distant area where concrete delivery was not possible. With its small footprint, fast erection and minimum concrete requirement C20 is a good choice for distant areas.

Gazprom is using C20 concrete plants for pump station construction in Siberia. Most of the equipment is delivered by helicopters. C20 was the best choice with its compact and robust structure.

Reference Projects

# C-20

Compact Concrete Batching Plant  
Capacity: 30 sec mixing - 20 m<sup>3</sup>/h

| Technical Data              | Value      | Unit               |
|-----------------------------|------------|--------------------|
| Capacity                    | 20         | m <sup>3</sup> /hr |
| Mixer Type                  | Planetary  | -                  |
| Mixer Capacity (compact)    | 0,33       | m <sup>3</sup>     |
| Motor Power                 | 15         | kW                 |
| Aggregate Compartments      | 4          | No.                |
| Aggregate Weighing Conveyor | 650x5.050  | mm                 |
| Mixer Feeding Conveyor      | Skip Hoist | mm                 |
| Aggregate Weighing Capacity | 700        | kg                 |
| Cement Weighing Capacity    | 170        | kg                 |
| Water Weighing Capacity     | 70         | kg                 |
| Additives Weighing Capacity | 15         | kg                 |

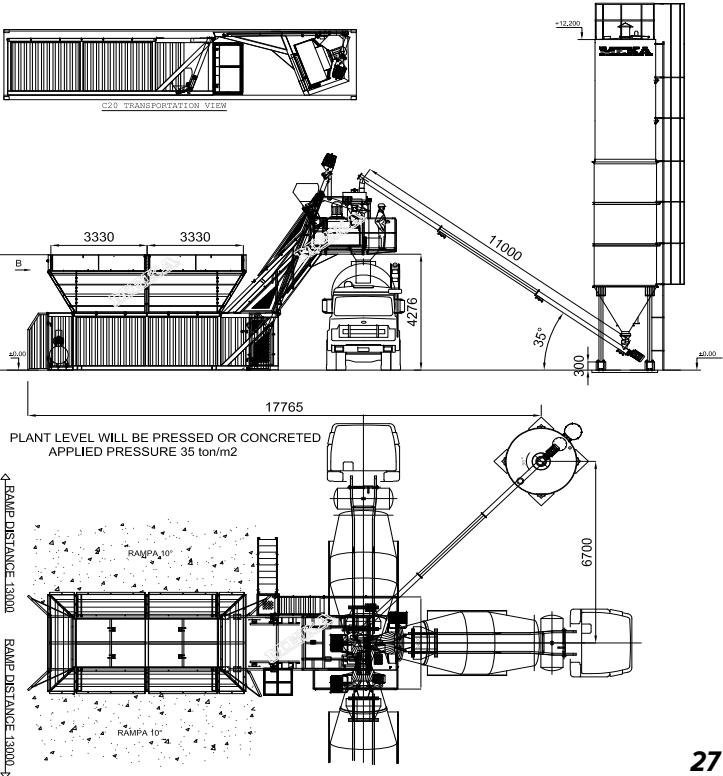





# C30 – Small but Capable

Sstroytransgaz-M – a subcontractor of Gazprom has undertaken the construction of a new portal on Novoportovskoe oil&gas field in Yamal, Western Siberia. Hard nature conditions are not an obstacle for a C30 concrete plant, that was chosen for this project.

The Belarus Republic plans to build 4 hydro-electric power plants: Polotskaya, Vitebskaya, Beshenkovicheskaya and Verhnedvinskaya within the scope of the energy safety policy that it aims to achieve until 2020.

A MEKA C30 compact batch plant with the winter option is capable of producing high-class and quality concrete even under the most challenging climate conditions.

Reference Projects

# C-30

Compact Concrete Batching Plant  
Capacity: 30 sec mixing - 30 m<sup>3</sup>/h

| Technical Data              | Value        | Unit               |
|-----------------------------|--------------|--------------------|
| Capacity                    | 30           | m <sup>3</sup> /hr |
| Mixer Type                  | Single Shaft | -                  |
| Mixer Capacity (compacted)  | 0,5          | m <sup>3</sup>     |
| Motor Power                 | 18,5         | kW                 |
| Aggregate Compartments      | 4            | No.                |
| Aggregate Weighing Conveyor | 650x5.050    | mm                 |
| Mixer Feeding Conveyor      | Skip Hoist   | mm                 |
| Aggregate Weighing Capacity | 1.100        | kg                 |
| Cement Weighing Capacity    | 300          | kg                 |
| Water Weighing Capacity     | 160          | lt                 |
| Additives Weighing Capacity | 20           | kg                 |

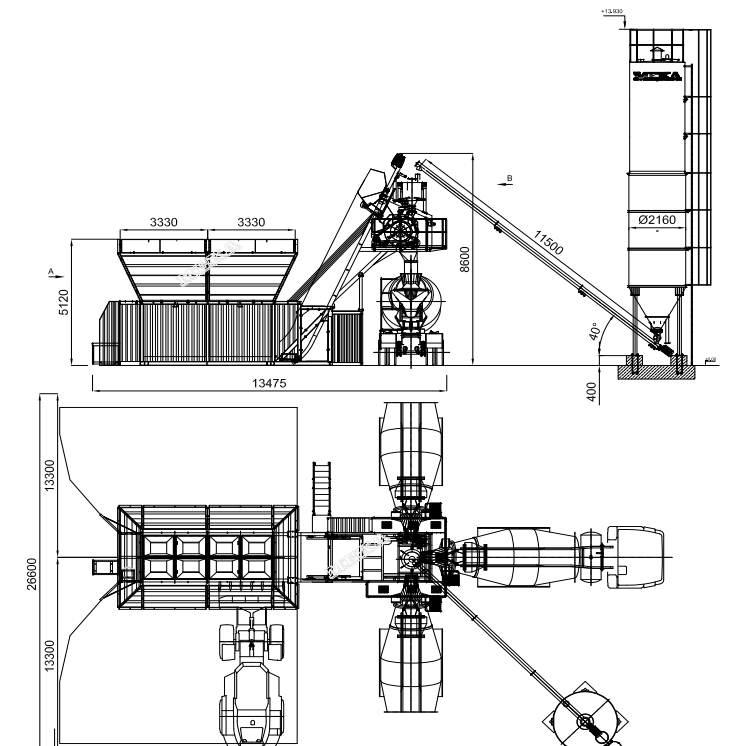



# 400 Million Dollar Automobile Factory and one MB-C60

Azia Avto, which is one of the largest automobile manufacturers of Kazakhstan, is using a MEKA C60 Compact Batch Plant in the construction of the new factory that it will have built at the Ust-Kamonogorsk city of East Kazakhstan.

Reference Projects

## C-60 Compact Concrete Batching Plant

Capacity: 30 sec mixing - 60 m<sup>3</sup>/h

| Technical Data              | Value        | Unit               |
|-----------------------------|--------------|--------------------|
| Capacity                    | 60           | m <sup>3</sup> /hr |
| Mixer Type                  | Single Shaft | -                  |
| Mixer Capacity (compacted)  | 1            | m <sup>3</sup>     |
| Motor Power                 | 37           | kW                 |
| Aggregate Compartments      | 3-4          | No.                |
| Aggregate Weighing Conveyor | 650x9.840    | m <sup>3</sup>     |
| Mixer Feeding Conveyor      | Skip Hoist   | mm                 |
| Aggregate Weighing Capacity | 2.200        | kg                 |
| Cement Weighing Capacity    | 500          | kg                 |
| Water Weighing Capacity     | 250          | lt                 |
| Additives Weighing Capacity | 20           | kg                 |

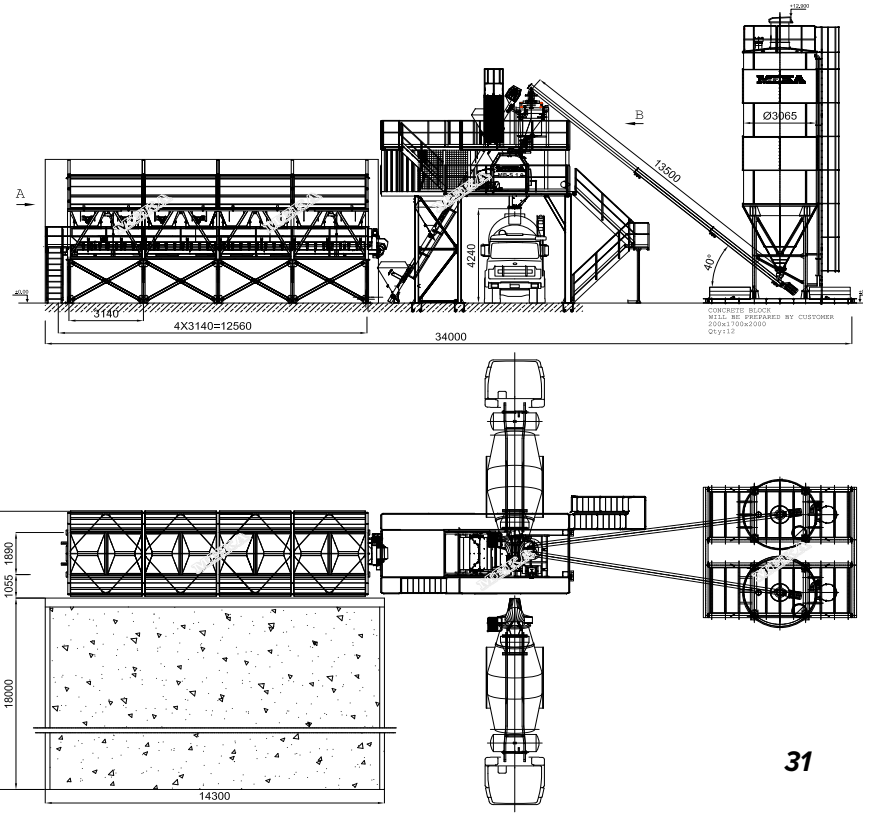



# Salalah Cement Trusts Meka In Natural Gas Projects

Salalah Cement, which is one of the most important companies in the city of Salalah in Oman, is using our C100 batch plant in the natural gas projects that are being conducted in 3 different spots.

Reference Projects

## C-100

### Compact Concrete Batching Plant

Capacity: 30 sec mixing - 85 m<sup>3</sup>/h, 20 sec mixing - 95 m<sup>3</sup>/h

| Technical Data              | Value        | Unit               |
|-----------------------------|--------------|--------------------|
| Capacity                    | 100          | m <sup>3</sup> /hr |
| Mixer Type                  | Twin Shaft   | -                  |
| Mixer Capacity (compacted)  | 2            | m <sup>3</sup>     |
| Motor Power                 | 2x37         | kW                 |
| Aggregate Compartments      | 4            | No.                |
| Aggregate Weighing Conveyor | 800x12.320   | mm                 |
| Mixer Feeding Conveyor      | 1.000x16.800 | mm                 |
| Aggregate Weighing Capacity | 6.600        | kg                 |
| Cement Weighing Capacity    | 1.000        | kg                 |
| Water Weighing Capacity     | 700          | kg                 |
| Additives Weighing Capacity | 20           | kg                 |

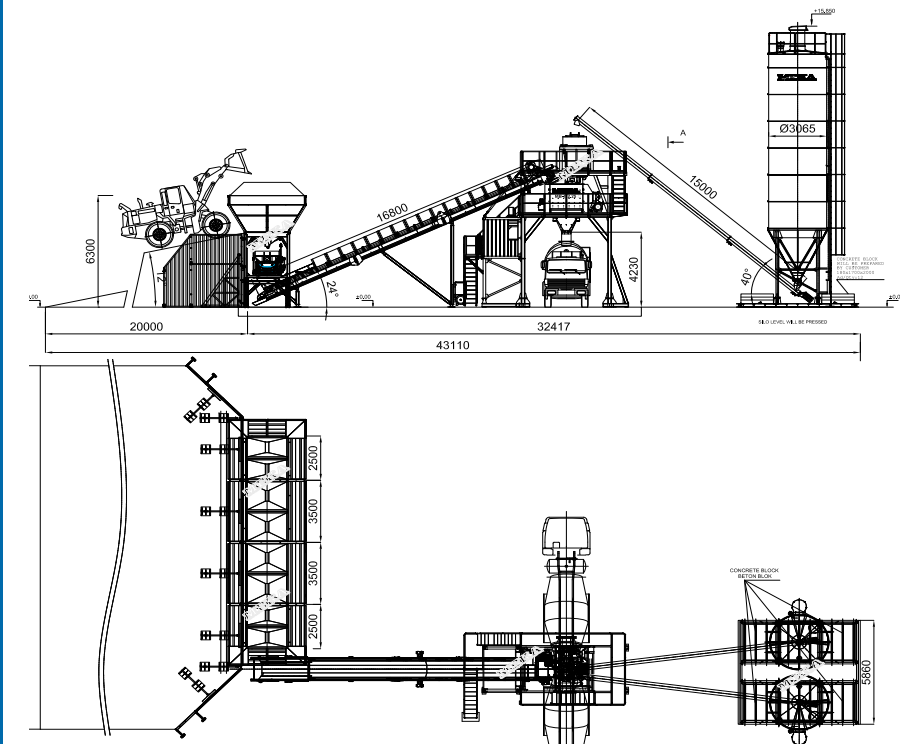





# Atlas Group and 3xC120

A big Turkish Contractor Atlas Group is among the biggest construction companies in the ENR list. Branch office in Algeria is using three MEKA MB-C120 concrete batch plants for the construction of Dr. Benzerjeb Hospital, Certic Cyber Park and Residential areas in different cities.

# Al Turki Enterprises The biggest contractor of Oman

Due to the high performance of 2x 2 120 m<sup>3</sup>/h Meka compact concrete plants that was used during Sohu Road Project in 2014 by Al Turki Enterprises Group opted to use Meka concrete batching plants in 2015, as well.

Reference Projects

# C-120 Compact Concrete Batching Plant

Capacity: 30 sec mixing - 115 m<sup>3</sup>/h, 20 sec mixing - 125 m<sup>3</sup>/h

| Technical Data              | Value        | Unit               |
|-----------------------------|--------------|--------------------|
| Capacity                    | 120          | m <sup>3</sup> /hr |
| Mixer Type                  | Twin Shaft   | -                  |
| Mixer Capacity (compacted)  | 3            | m <sup>3</sup>     |
| Motor Power                 | 2x55         | kW                 |
| Aggregate Compartments      | 4            | No.                |
| Aggregate Weighing Conveyor | 800x12.320   | mm                 |
| Mixer Feeding Conveyor      | 1.000x16.800 | mm                 |
| Aggregate Weighing Capacity | 6.600        | kg                 |
| Cement Weighing Capacity    | 1.750        | kg                 |
| Water Weighing Capacity     | 1000         | kg                 |
| Additives Weighing Capacity | 40           | kg                 |

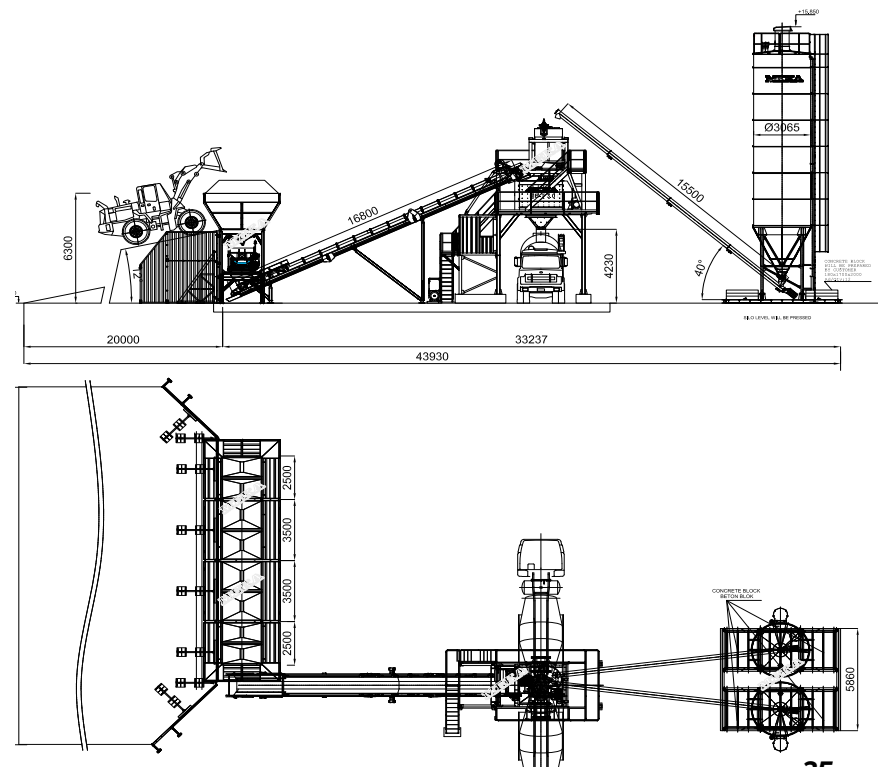



# MOBILE CONCRETE PLANTS



## PRODUCTS

# Mobile Concrete Plants

*MEKA's comprehensive range of batching plants and concrete mixers provides our customers with an unrivalled industry choice of equipment, to meet every application.*

With over 30 years of manufacturing and design experience, combined with a superior technological infrastructure, MEKA have developed a unique and robust range of quick erect, mobile concrete batching solutions, which have become internationally renowned for their high quality and reliability.

MEKA Mobile Concrete Plants are rapidly becoming the preferred choice for many of the world's construction and concrete producing professionals from around the world.

MEKA's unique portable design provides quick and easy erection and reallocation and is proven to lower operational and maintenance costs, which provides increased confidence, due to minimal breakdowns.

At the heart of every portable concrete plant, beats one of our specially designed, high quality Single Shaft or Twin Shaft Mixers, which are proven in the production of all types of high quality and high performance, concrete mixtures.





# Ethiopian Railway Project Will Rise With 6 Meka Concrete Plants

The Ethiopian Awash-Kombolcha-Hara-Gebaya Railway Project, with a budget of 1.7 billion USD, was opened in the Groundbreaking Ceremony on February 25, 2015 in Kombolcha.

The main contractor is a well-known Turkish company – Yapi Merkezi. Since the Project is spread across the railway line a fast erect mobile concrete plant was required for frequent relocations. A 30M mobile concrete plant and other models were preferred.

Reference Projects

## MB-30M

Mobile Concrete Batching Plant

Capacity: 30 sec mixing - 27 m<sup>3</sup>/h, 20 sec mixing - 32 m<sup>3</sup>/h

| Technical Data                  | Value       | Unit               |
|---------------------------------|-------------|--------------------|
| Capacity                        | 30          | m <sup>3</sup> /hr |
| Mixer Type                      | Singleshaft | -                  |
| Mixer Capacity (compacted)      | 0,5         | m <sup>3</sup>     |
| Motor Power                     | 18,5        | kW                 |
| Aggregate Compartments          | 4           | No.                |
| Aggregate Compartment Capacity  | 7           | m <sup>3</sup>     |
| Aggregate Weighing Conveyor     | 650x13.480  | mm                 |
| Mixer Feeding Conveyor          | 650x13.480  | mm                 |
| Aggregate Weighing Capacity     | 1100        | kg                 |
| Cement Weighing Capacity        | 300         | kg                 |
| Water Weighing Capacity         | 160         | kg                 |
| Additives Weighing Capacity     | 15          | kg                 |
| Built-in Cement Silo (Optional) | 22          | ton                |

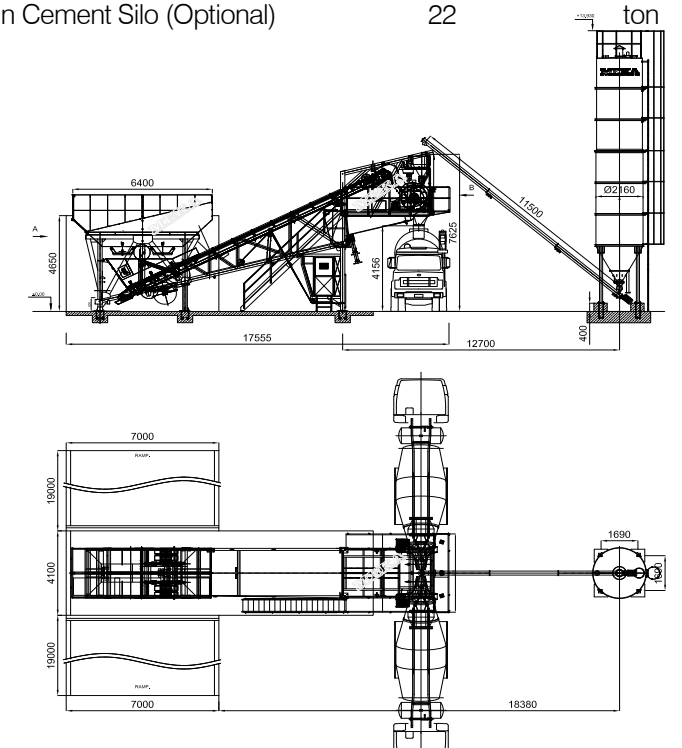





# 11 MB-60M For The Government Of Algeria

Professionals choice MEKA has recently made the delivery of 11 batching plants MB-60M with 60 m<sup>3</sup>/h capacity to Algeria for a governmental project of mass housing.

Reference Projects

## MB-60M

Mobile Concrete Batching Plant

Capacity: 30 sec mixing - 54 m<sup>3</sup>/h, 20 sec mixing - 63 m<sup>3</sup>/h

| Technical Data                  | Value        | Unit               |
|---------------------------------|--------------|--------------------|
| Capacity                        | 60           | m <sup>3</sup> /hr |
| Mixer Type                      | Single Shaft | -                  |
| Mixer Capacity (compacted)      | 1            | m <sup>3</sup>     |
| Motor Power                     | 37           | kW                 |
| Aggregate Compartments          | 4            | No.                |
| Aggregate Compartment Capacity  | 10           | m <sup>3</sup>     |
| Aggregate Weighing Conveyor     | 800x13.710   | mm                 |
| Mixer Feeding Conveyor          | 800x13.710   | mm                 |
| Aggregate Weighing Capacity     | 2.200        | kg                 |
| Cement Weighing Capacity        | 500          | kg                 |
| Water Weighing Capacity         | 250          | kg                 |
| Additives Weighing Capacity     | 15           | kg                 |
| Built-in Cement Silo (Optional) | 30           | ton                |

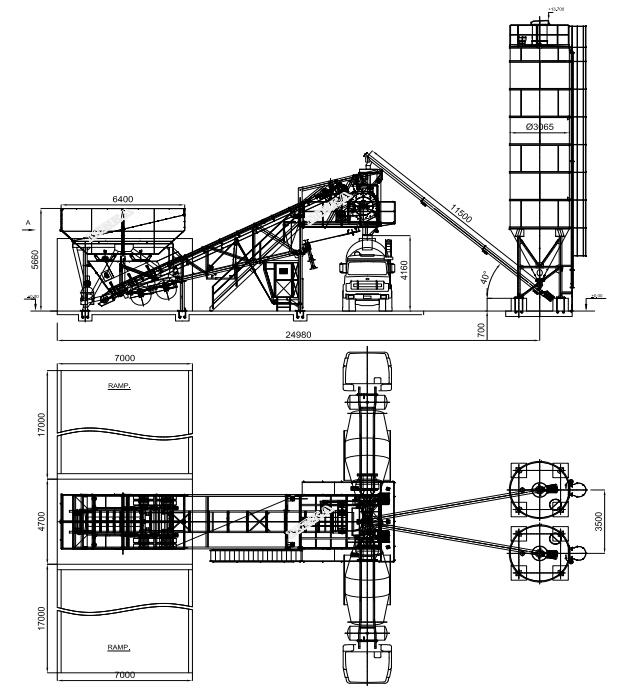



# Designed for Perfect Transportation Dimensions

MB-60ML concrete plant was designed with perfect transportation dimensions in mind. It does not require special permissions from local authorities.

Reference Projects

## MB-60ML

Mobile Concrete Batching Plant

Capacity: 30 sec mixing - 54 m<sup>3</sup>/h, 20 sec mixing - 63 m<sup>3</sup>/h

| Technical Data                 | Value        | Unit               |
|--------------------------------|--------------|--------------------|
| Capacity                       | 60           | m <sup>3</sup> /hr |
| Mixer Type                     | Single Shaft | -                  |
| Mixer Capacity (compacted)     | 1            | m <sup>3</sup>     |
| Motor Power                    | 37           | kW                 |
| Aggregate Compartments         | 4            | No.                |
| Aggregate Compartment Capacity | 12           | m <sup>3</sup>     |
| Aggregate Weighing Conveyor    | 650x13.710   | mm                 |
| Mixer Feeding Conveyor         | 650x13.710   | mm                 |
| Aggregate Weighing Capacity    | 2.200        | kg                 |
| Cement Weighing Capacity       | 500          | kg                 |
| Water Weighing Capacity        | 250          | lt                 |
| Additives Weighing Capacity    | 20           | kg                 |
| Built-in Cement Silo           | -            | ton                |

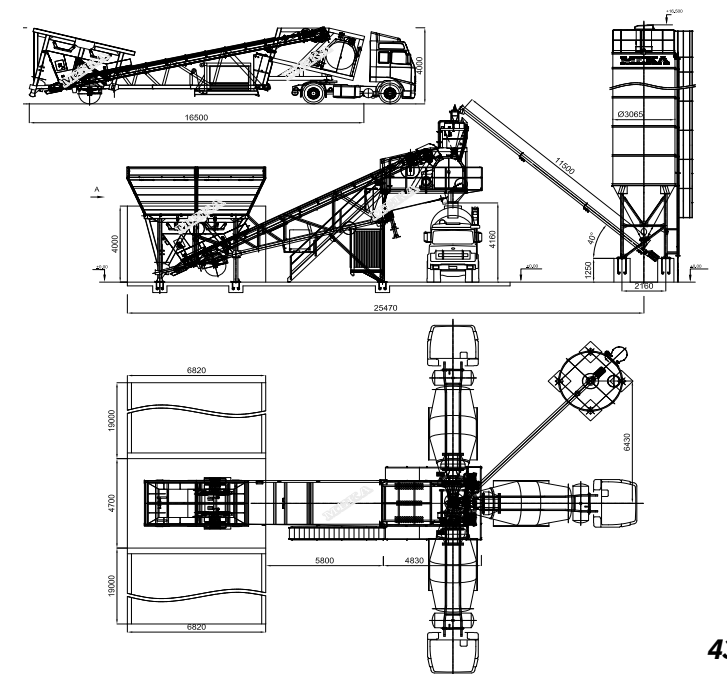



# 5 Mb-100M Concrete Plants For Heidelberg Cement

Heidelberg Cement is operating five MB-100M Concrete Batching Plants in different locations in Georgia along with two more plants of different capacities. Long-term cooperation with mutual benefit for both parties is one of our main goals.

Reference Projects

## MB-100M

Mobile Concrete Batching Plant

Capacity: 30 sec mixing - 83 m<sup>3</sup>/h, 20 sec mixing - 94 m<sup>3</sup>/h

| Technical Data                 | Value        | Unit               |
|--------------------------------|--------------|--------------------|
| Capacity                       | 100          | m <sup>3</sup> /hr |
| Mixer Type                     | Twin Shaft   | -                  |
| Mixer Capacity (compacted)     | 2            | m <sup>3</sup>     |
| Motor Power                    | 2x37         | kW                 |
| Aggregate Compartments         | 4            | No.                |
| Aggregate Compartment Capacity | 15           | m <sup>3</sup>     |
| Aggregate Weighing Conveyor    | 1.000x15.630 | mm                 |
| Mixer Feeding Conveyor         | 1.000x15.630 | mm                 |
| Aggregate Weighing Capacity    | 4.400        | kg                 |
| Cement Weighing Capacity       | 1.000        | kg                 |
| Water Weighing Capacity        | 700          | kg                 |
| Additives Weighing Capacity    | 20           | kg                 |

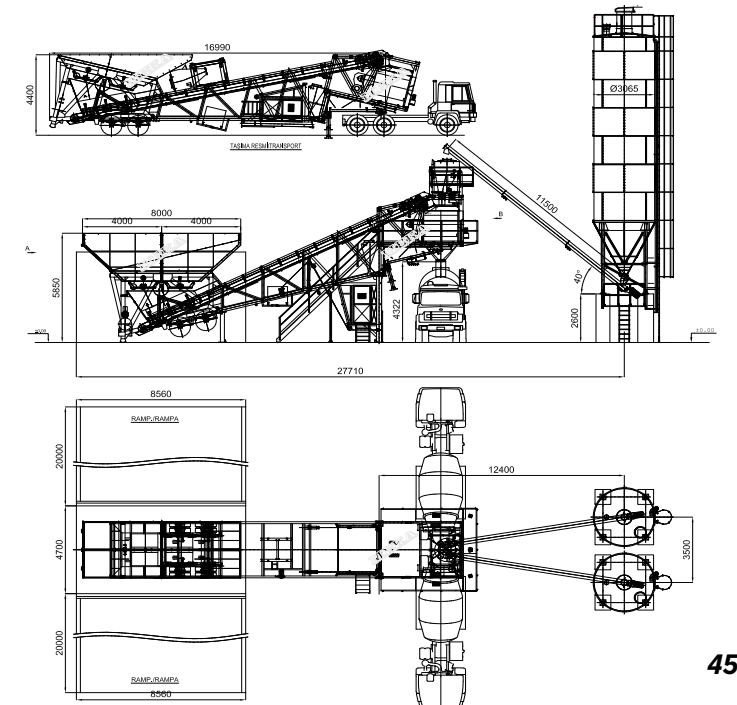







# A 120BM in the middle of London for Battersea Power Station

London Concrete, a subsidiary of Aggregate Industries/ LafargeHolcim in the UK, have recently invested in a Meka MB-120BM mobile batching plant to compliment their existing business in Greater London. The MB120 compact mobile plant, has been configured with high volume aggregate and cement storage in order to maintain the demands of the prestigious London Markets.

Reference Projects

## MB-120BM

Mobile Concrete Batching Plant

Capacity: 30 sec mixing - 113 m<sup>3</sup>/h, 20 sec mixing - 126 m<sup>3</sup>/h

| Technical Data                 | Value        | Unit               |
|--------------------------------|--------------|--------------------|
| Capacity                       | 120          | m <sup>3</sup> /hr |
| Mixer Type                     | Twin Shaft   | -                  |
| Mixer Capacity (compacted)     | 3            | m <sup>3</sup>     |
| Motor Power                    | 2x55         | kW                 |
| Aggregate Compartments         | 4            | No.                |
| Aggregate Compartment Capacity | 25           | m <sup>3</sup>     |
| Aggregate Weighing Conveyor    | 1.000x14.480 | mm                 |
| Mixer Feeding Conveyor         | 1.000x17.730 | mm                 |
| Aggregate Weighing Capacity    | 6.000        | kg                 |
| Cement Weighing Capacity       | 1.750        | kg                 |
| Water Weighing Capacity        | 1.000        | kg                 |
| Additives Weighing Capacity    | 40           | kg                 |
| Built-in Cement Silo           | -            | ton                |

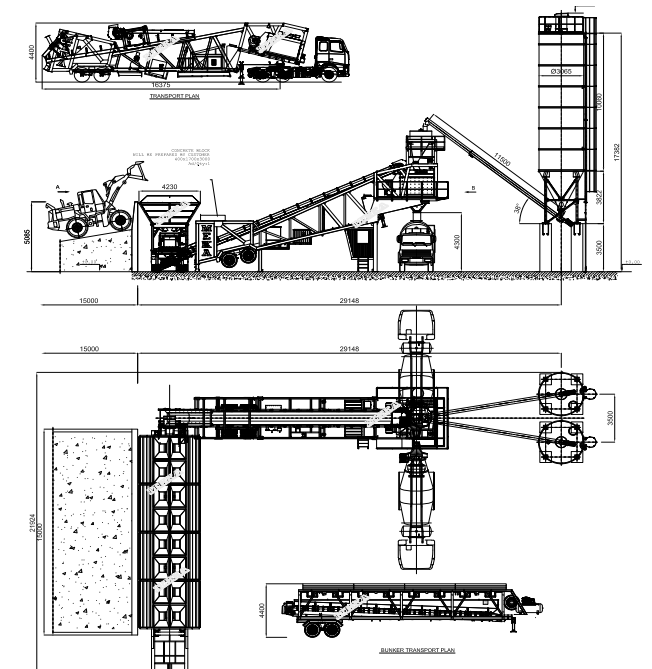





# Mobile Mixer System

Need to transform your dry-batch concrete plant into a wet-batch one?  
 Long-term complete transformation of the existing plant with changing the length of the belt conveyors, making new structure for mixer platform etc. is generally not cost-effective with high labor and foundation expenses. However, there is a solution - MEKA Mobile Mixers.

| Type                      | 2.0m <sup>3</sup>    | 3.0m <sup>3</sup>    | 3.5m <sup>3</sup>    | 4.0m <sup>3</sup>     | 4.5m <sup>3</sup>     |
|---------------------------|----------------------|----------------------|----------------------|-----------------------|-----------------------|
| Feeding Capacity          | 3.000 Lt             | 4.500 Lt             | 5.250 Lt             | 6.000 Lt              | 6.750 Lt              |
| Mixer Motor Power         | 2.000 Lt             | 3.000 Lt             | 3.500 Lt             | 4.000 Lt              | 4.500 Lt              |
| Conveyor Belt             | 1.200 X 16.000 Mm    |                      |                      |                       |                       |
| Belt Motor Power          | 30 Kw                | 30Kw                 | 30Kw                 | 45Kw                  | 45Kw                  |
| Compacted Concrete Output | 66M <sup>3</sup> /Hr | 80M <sup>3</sup> /Hr | 95M <sup>3</sup> /Hr | 105M <sup>3</sup> /Hr | 120M <sup>3</sup> /Hr |

| Type   | 2.0m <sup>3</sup> | 3.0m <sup>3</sup> | 3.5m <sup>3</sup> | 4.0m <sup>3</sup> | 4.5m <sup>3</sup> |
|--------|-------------------|-------------------|-------------------|-------------------|-------------------|
| W      | 3.000 mm          |                   |                   |                   |                   |
| H      | 4.000 mm          |                   |                   |                   |                   |
| L      | 12.250 mm         |                   |                   |                   |                   |
| WEIGHT | 26.500Kg          | 28.000Kg          | 28.500Kg          | 31.000Kg          | 31.400Kg          |





# STATIONARY CONCRETE PLANTS



## Stationary Concrete Plants

*Meeting our customers' expectations, we take pride in our flexible engineering solutions for different applications.*

MEKA stationary concrete batching plants have been designed for maximum efficiency and reliability for producing all types of high quality concretes, with production outputs from 30m<sup>3</sup> to 250m<sup>3</sup> per hour.

MEKA's stationary plants are available with a variety of options and can be configured to meet each client's individual needs. There are more than 1500 MEKA concrete plants running all over the world in different climatic conditions helping to build better infrastructure, better cities and better life. We are aware of how important is the role of a concrete plant in completing a project.

Keeping it in mind we design stable and long lasting structures, we have one of the best after-sales teams which is ready to help in minutes where possible and we use high-quality components (like WAM, SIEMENS, FESTO) which are available worldwide to make sure that our customers rely on equipment they purchased and are not bind to us in solving minor service issues.





# One MB-30WS travelled more than 15.000km in containers

A MEKA MB-30WS Concrete Plant was chosen for the reconstruction of large residential areas in Petropavlovsk-Kamchatski, Russia. The distant location was a challenge but since 30WS can fit in standard 40FT OT containers the delivery was just a matter of time.

Reference Projects

## MB-30WS Stationary Concrete Batching Plant

Capacity: 30 sec mixing - 30 m<sup>3</sup>/h

| Technical Data              | Value        | Unit               |
|-----------------------------|--------------|--------------------|
| Capacity                    | 30           | m <sup>3</sup> /hr |
| Mixer Type                  | Single Shaft | -                  |
| Mixer Capacity (compacted)  | 0,5          | m <sup>3</sup>     |
| Motor Power                 | 18,5         | kW                 |
| Aggregate Compartments      | 3-4          | No.                |
| Aggregate Weighing Conveyor | 800x9.850    | mm                 |
| Mixer Feeding Conveyor      | Skip Hoist   | mm                 |
| Aggregate Weighing Capacity | 1.100        | kg                 |
| Cement Weighing Capacity    | 300          | kg                 |
| Water Weighing Capacity     | 160          | kg                 |
| Additives Weighing Capacity | 20           | kg                 |

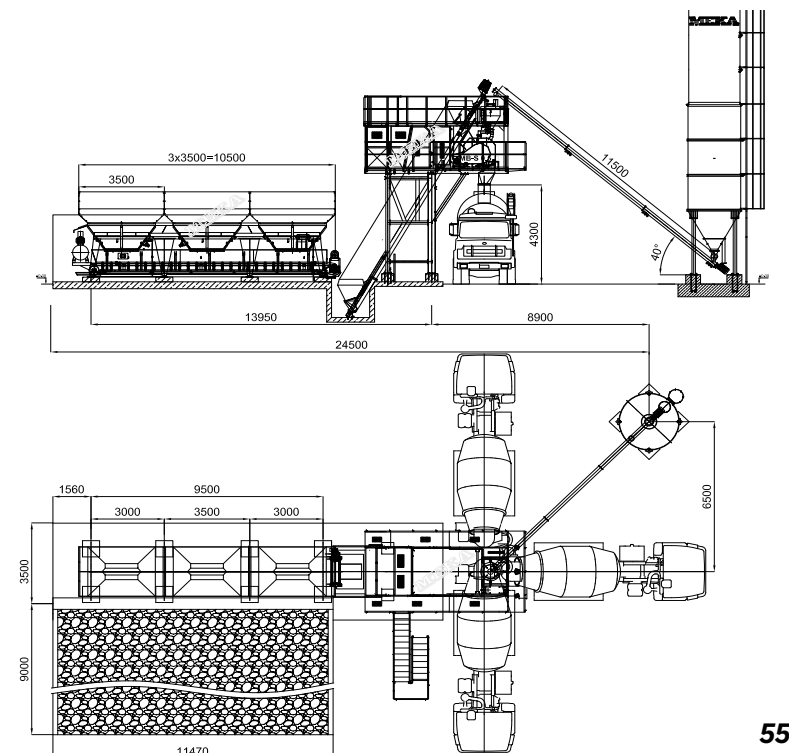



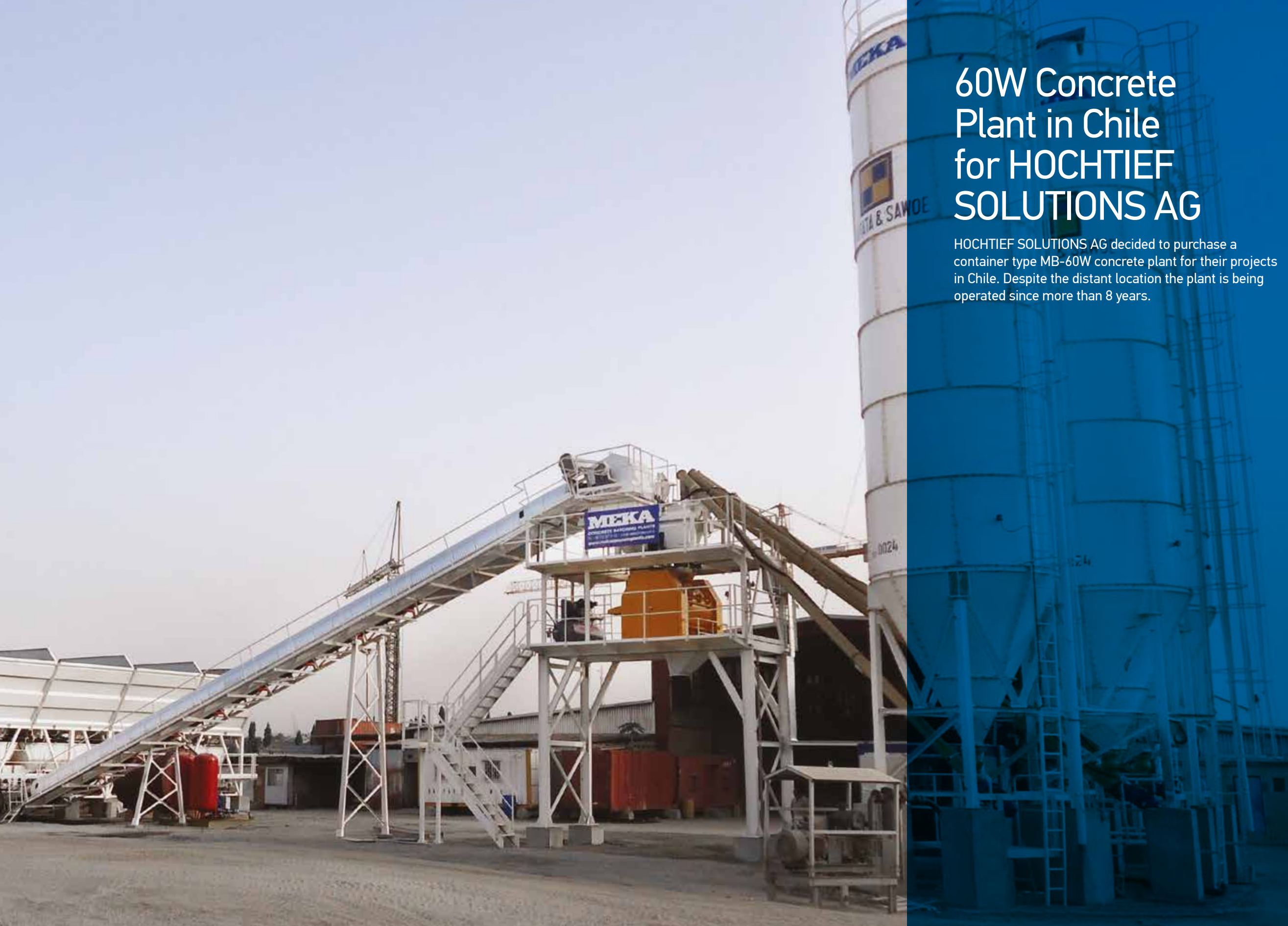

Reference Projects

# 60W Concrete Plant in Chile for HOCHTIEF SOLUTIONS AG

HOCHTIEF SOLUTIONS AG decided to purchase a container type MB-60W concrete plant for their projects in Chile. Despite the distant location the plant is being operated since more than 8 years.

## MB-60W Stationary Concrete Batching Plant

Capacity: 30 sec mixing - 60 m<sup>3</sup>/h, 20 sec mixing - 72 m<sup>3</sup>/h

| Technical Data              | Value        | Unit               |
|-----------------------------|--------------|--------------------|
| Capacity                    | 60           | m <sup>3</sup> /hr |
| Mixer Type                  | Single Shaft | -                  |
| Mixer Capacity (compacted)  | 1            | m <sup>3</sup>     |
| Motor Power                 | 37           | kW                 |
| Aggregate Compartments      | 3-4          | No.                |
| Aggregate Weighing Conveyor | 800x14.350   | mm                 |
| Mixer Feeding Conveyor      | 800x29.000   | mm                 |
| Aggregate Weighing Capacity | 2.200        | kg                 |
| Cement Weighing Capacity    | 500          | kg                 |
| Water Weighing Capacity     | 250          | kg                 |
| Additives Weighing Capacity | 20           | kg                 |

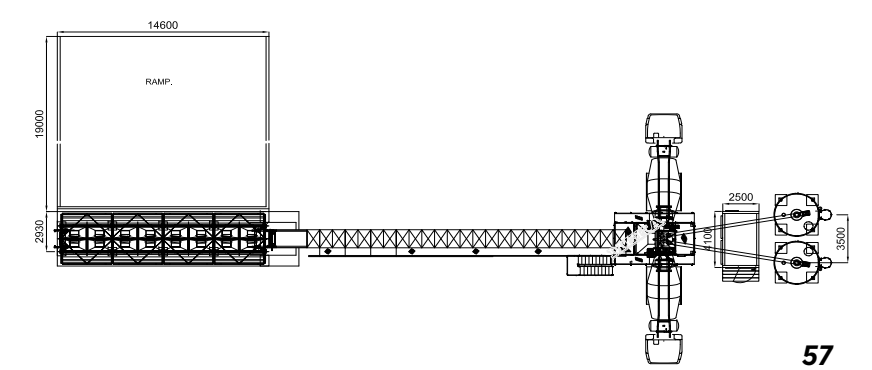
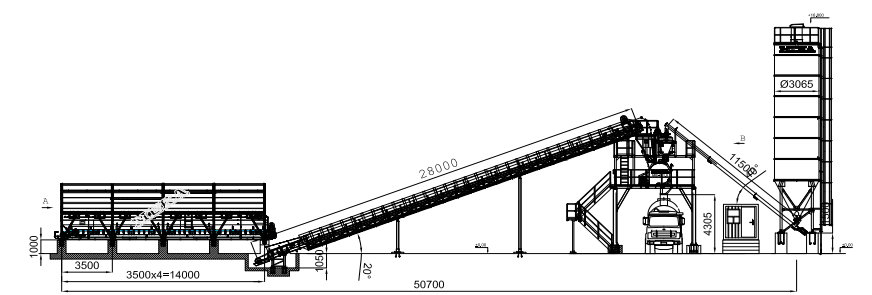





# MEKA Behind the Most Significant Project of Oman

The Stage 1A of the road project between Biddid and Sur in Oman was constructed by the joint venture of the Italian construction company Astaldi and the Turkish contractor Özkar İnşaat. MB-100W and MB-120W MEKA concrete plants were chosen to fulfill the concrete requirements.

A customized model of a MB-100W concrete plant with Wet and Dry option was recently installed for a well-known ready-mix giant S. Morris in UK.

Reference Projects

## MB-100W Stationary Concrete Batching Plant

Capacity: 30 sec mixing - 96 m<sup>3</sup>/h, 20 sec mixing - 111 m<sup>3</sup>/h

| Technical Data              | Value        | Unit               |
|-----------------------------|--------------|--------------------|
| Capacity                    | 100          | m <sup>3</sup> /hr |
| Mixer Type                  | Twin Shaft   | -                  |
| Mixer Capacity (compacted)  | 2            | m <sup>3</sup>     |
| Motor Power                 | 2x37         | kW                 |
| Aggregate Compartments      | 3-4          | No.                |
| Aggregate Weighing Conveyor | 1.000x15.630 | mm                 |
| Mixer Feeding Conveyor      | 1.000x29.000 | mm                 |
| Aggregate Weighing Capacity | 4.400        | kg                 |
| Cement Weighing Capacity    | 1000         | kg                 |
| Water Weighing Capacity     | 700          | kg                 |
| Additives Weighing Capacity | 20           | kg                 |

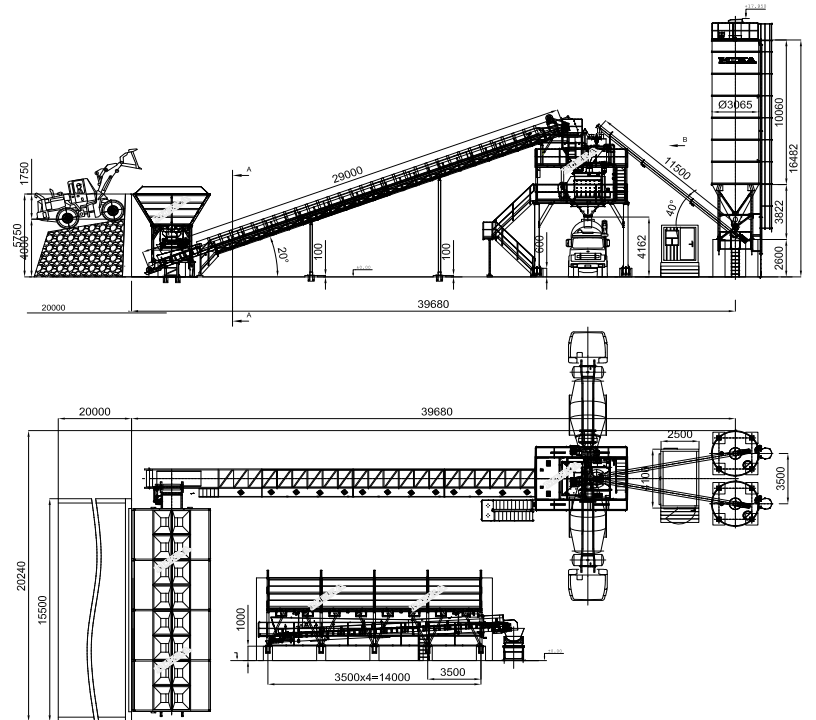





# When space is limited. Skip hoist concrete plants are the best choice for limited areas

Rabban Readymix – one of the most known concrete manufacturers of Qatar is among the MEKA customers since more than 10 years, operating 5 units of different capacities. Long term cooperation with mutual benefit is always our priority.

Reference Projects

## MB-100WS Stationary Concrete Batching Plant

Capacity: 30 sec mixing - 96 m<sup>3</sup>/h

| Technical Data              | Value        | Unit               |
|-----------------------------|--------------|--------------------|
| Capacity                    | 100          | m <sup>3</sup> /hr |
| Mixer Type                  | Twin Shaft   | -                  |
| Mixer Capacity (compacted)  | 2            | m <sup>3</sup>     |
| Motor Power                 | 2x37         | kW                 |
| Aggregate Compartments      | 4-6          | No.                |
| Aggregate Weighing Conveyor | 1.000x15.630 | mm                 |
| Mixer Feeding Conveyor      | Skip Hoist   | mm                 |
| Aggregate Weighing Capacity | 4.400        | kg                 |
| Cement Weighing Capacity    | 1.000        | kg                 |
| Water Weighing Capacity     | 700          | kg                 |
| Additives Weighing Capacity | 20           | kg                 |

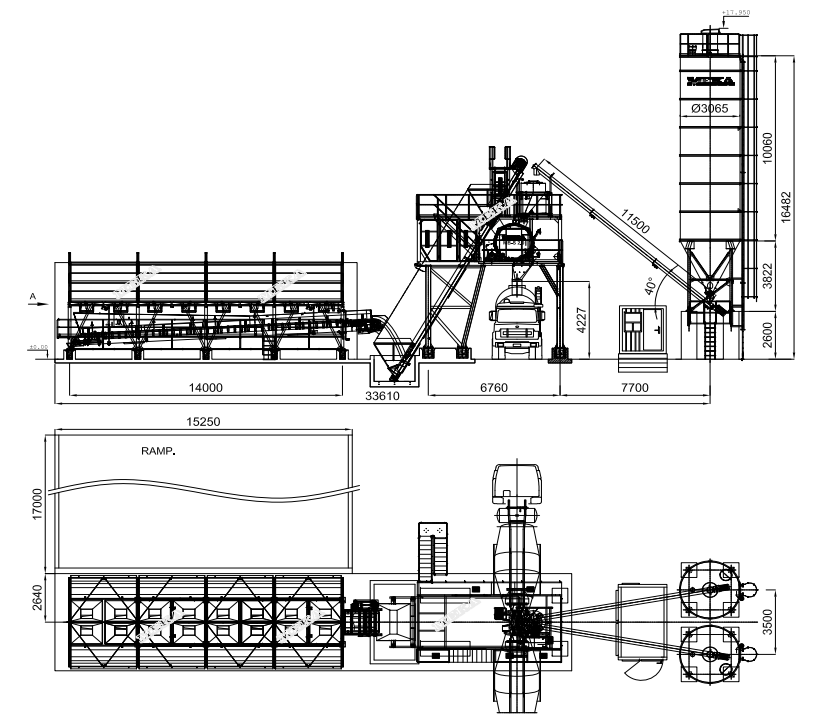





# MB-110K

## One of the most demanded models

Being designed as a modular structure the main chassis is completely galvanized. Advanced Readymix – one of the biggest and well-known ready-mix manufacturers in Jordan was the first happy customers to start the operation of this model. K110 was the second plant after one MB-120W was installed the same year.

MB-110K of FIFA 2018 projects on PSO Kazan is one of the construction companies in Russia that is involved in the construction of new stadiums for FIFA 2018 projects. A MB-110K model will be manufacturing concrete for the stadium located in Samara.

Reference Projects

# MB-110K

## Stationary Concrete Batching Plant

Capacity: 30 sec mixing - 105 m<sup>3</sup>/h, 20 sec mixing - 117 m<sup>3</sup>/h

| Technical Data              | Value       | Unit               |
|-----------------------------|-------------|--------------------|
| Capacity                    | 105-117     | m <sup>3</sup> /hr |
| Mixer Type                  | Twin Shaft  | -                  |
| Mixer Capacity (compacted)  | 2,25        | m <sup>3</sup>     |
| Motor Power                 | 2x37        | kW                 |
| Aggregate Compartments      | 3-5         | No.                |
| Aggregate Weighing Conveyor | 800x13.000  | mm                 |
| Mixer Feeding Conveyor      | 1000x29.000 | mm                 |
| Aggregate Weighing Capacity | 5.000       | kg                 |
| Cement Weighing Capacity    | 1.250       | kg                 |
| Water Weighing Capacity     | 700         | kg                 |
| Additives Weighing Capacity | 20          | kg                 |

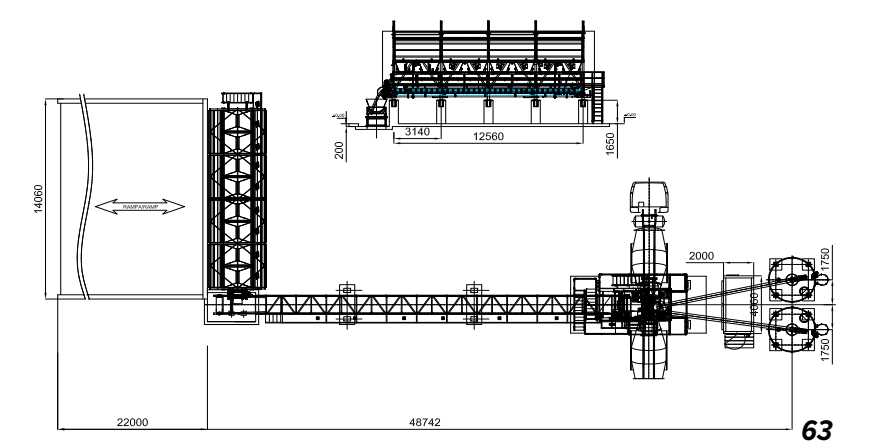
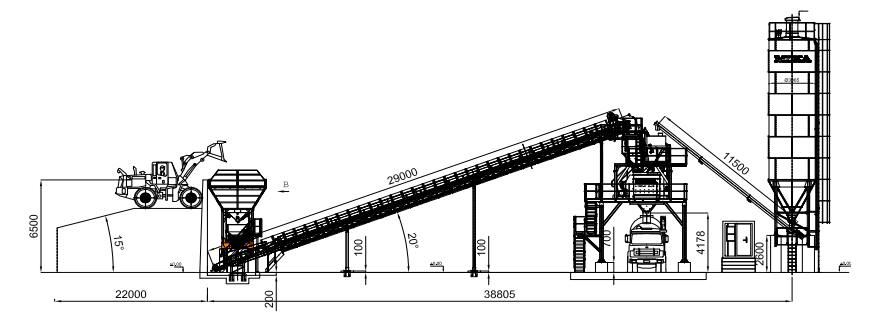



# MEKA on the construction of 3rd Bosphorus Bridge

The Northern Marmara Expressway Project (Odayeri – Pasakoy Section), the construction of which is going on within the scope of the 3rd Bosphorus Bridge project, is one of the most important projects of Turkey. MB-120W Stationary Concrete Plant, which is located at the Istanbul Uskumrukoy premises, is manufacturing high quality concrete classes, like C35, C45 and C55 for the girders. At the Uskumrukoy premises 8 pieces of 1180 pre-stressed girders will be produced with total volume of 250,000m<sup>3</sup> of precast concrete.

Reference Projects

## MB-120W Stationary Concrete Batching Plant

Capacity: 30 sec mixing - 127 m<sup>3</sup>/h, 20 sec mixing - 144 m<sup>3</sup>/h

| Technical Data              | Value        | Unit               |
|-----------------------------|--------------|--------------------|
| Capacity                    | 120          | m <sup>3</sup> /hr |
| Mixer Type                  | Twin Shaft   | -                  |
| Mixer Capacity (compacted)  | 3            | m <sup>3</sup>     |
| Motor Power                 | 2x55         | kW                 |
| Aggregate Compartments      | 4-6          | No.                |
| Aggregate Weighing Conveyor | 1.000x15.630 | mm                 |
| Mixer Feeding Conveyor      | 1.000x31.500 | mm                 |
| Aggregate Weighing Capacity | 6.600        | kg                 |
| Cement Weighing Capacity    | 1.750        | kg                 |
| Water Weighing Capacity     | 1.000        | kg                 |
| Additives Weighing Capacity | 40           | kg                 |

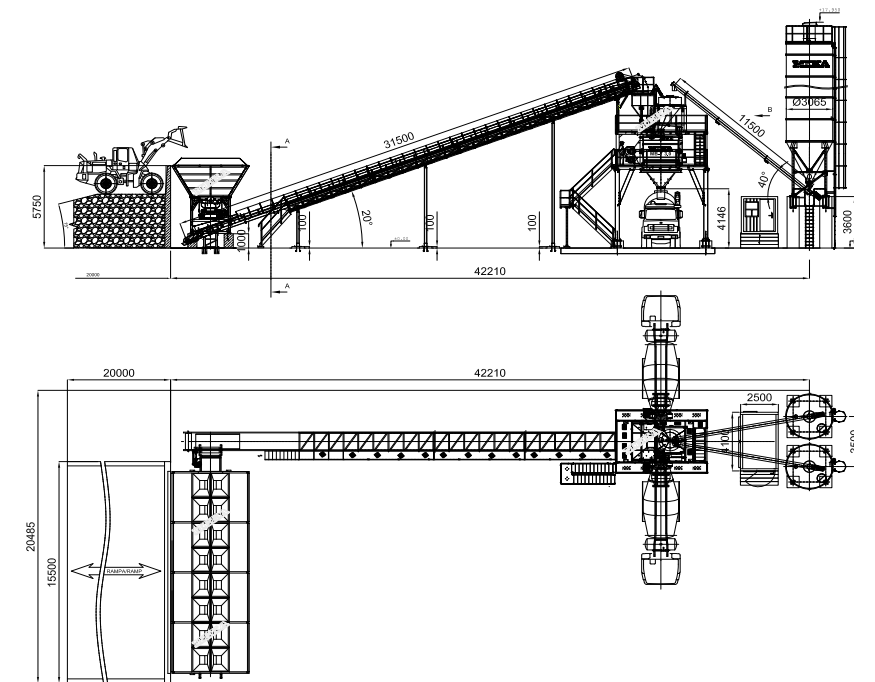





# MB-150W for National Industries Company in Kuwait

National Industries Company (NIC) is the leading and one of the most prestigious companies specialized in the manufacture and marketing of building materials and infra-structure products in the State of Kuwait. NIC and MEKA have been partners in excellence since many years.

Reference Projects

## MB-150W Stationary Concrete Batching Plant

Capacity: 30 sec mixing - 155 m<sup>3</sup>/h, 20 sec mixing - 174 m<sup>3</sup>/h

| Technical Data              | Value          | Unit               |
|-----------------------------|----------------|--------------------|
| Capacity                    | 150            | m <sup>3</sup> /hr |
| Mixer Type                  | Twin Shaft     | -                  |
| Mixer Capacity (compacted)  | 4              | m <sup>3</sup>     |
| Motor Power                 | 2x75           | kW                 |
| Aggregate Compartments      | 6-8            | No.                |
| Aggregate Weighing Conveyor | 2x1.000x12.000 | mm                 |
| Mixer Feeding Conveyor      | 1.200x34.750   | mm                 |
| Aggregate Weighing Capacity | 8.800          | kg                 |
| Cement Weighing Capacity    | 2.000          | kg                 |
| Water Weighing Capacity     | 1.200          | kg                 |
| Additives Weighing Capacity | 40             | kg                 |

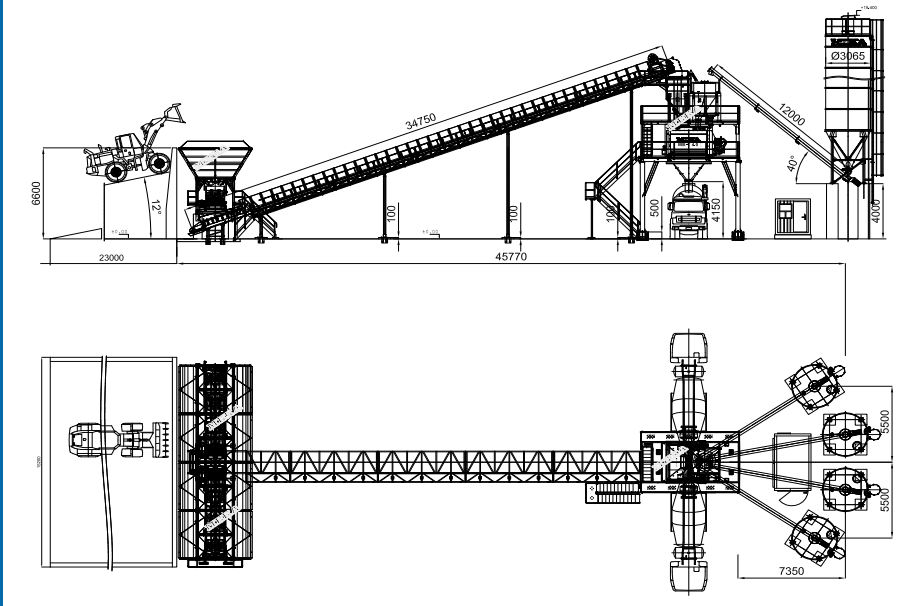





# Meka And Lafarge On Construction Of “Doha Metro” Lines Project

The Qatar’s capital city – Doha will have one of the most advanced metro systems in the world by the end of 2019. MEKA presented to the project it’s renowned product - Stationary Concrete Batching Plant MEKA MB-180W (180 m<sup>3</sup>/h). Concrete Batching Plant was installed and commissioned at the Lafarge’s worksite near the Al Rayyan highway, located right in the center of the project.

### *MEKA and Lafarge in more than 10 countries*

The collaboration of MEKA and Lafarge has started in 2010 when first plants were supplied to Nigeria. Today there are more than 20 MEKA concrete batching plants operated by Lafarge Affiliates worldwide.

Reference Projects

## MB-180W Stationary Concrete Batching Plant

Capacity: 30 sec mixing - 167 m<sup>3</sup>/h, 20 sec mixing - 186 m<sup>3</sup>/h

| Technical Data              | Value          | Unit               |
|-----------------------------|----------------|--------------------|
| Capacity                    | 180            | m <sup>3</sup> /hr |
| Mixer Type                  | Twin Shaft     | -                  |
| Mixer Capacity (compacted)  | 4,5            | m <sup>3</sup>     |
| Motor Power                 | 2x90           | kW                 |
| Aggregate Compartments      | 6-8            | No.                |
| Aggregate Weighing Conveyor | 2x1.000x12.000 | mm                 |
| Mixer Feeding Conveyor      | 1.200x34.750   | mm                 |
| Aggregate Weighing Capacity | 9.900          | kg                 |
| Cement Weighing Capacity    | 2.000          | kg                 |
| Water Weighing Capacity     | 1.200          | kg                 |
| Additives Weighing Capacity | 60             | kg                 |

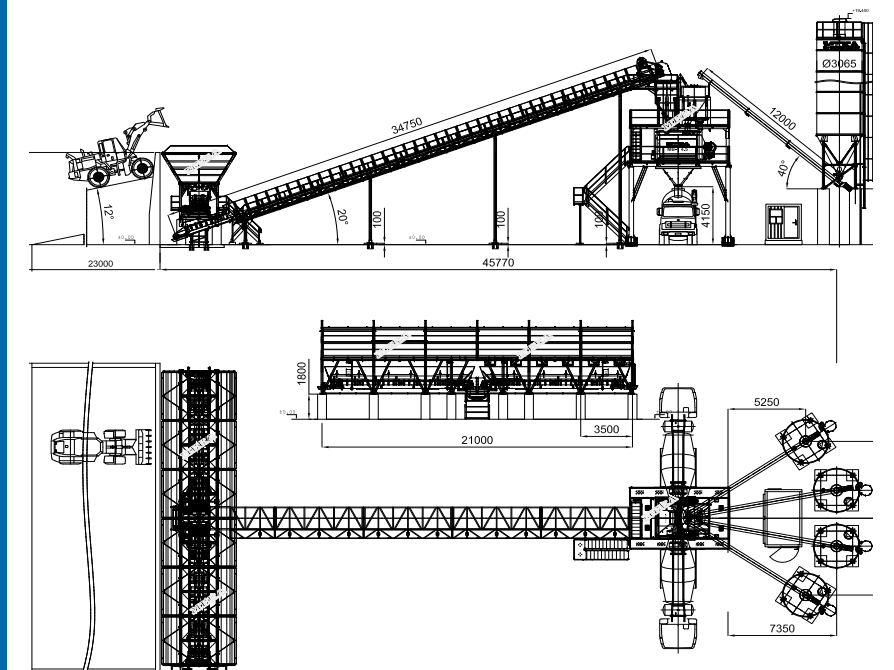



# AUTOMATION

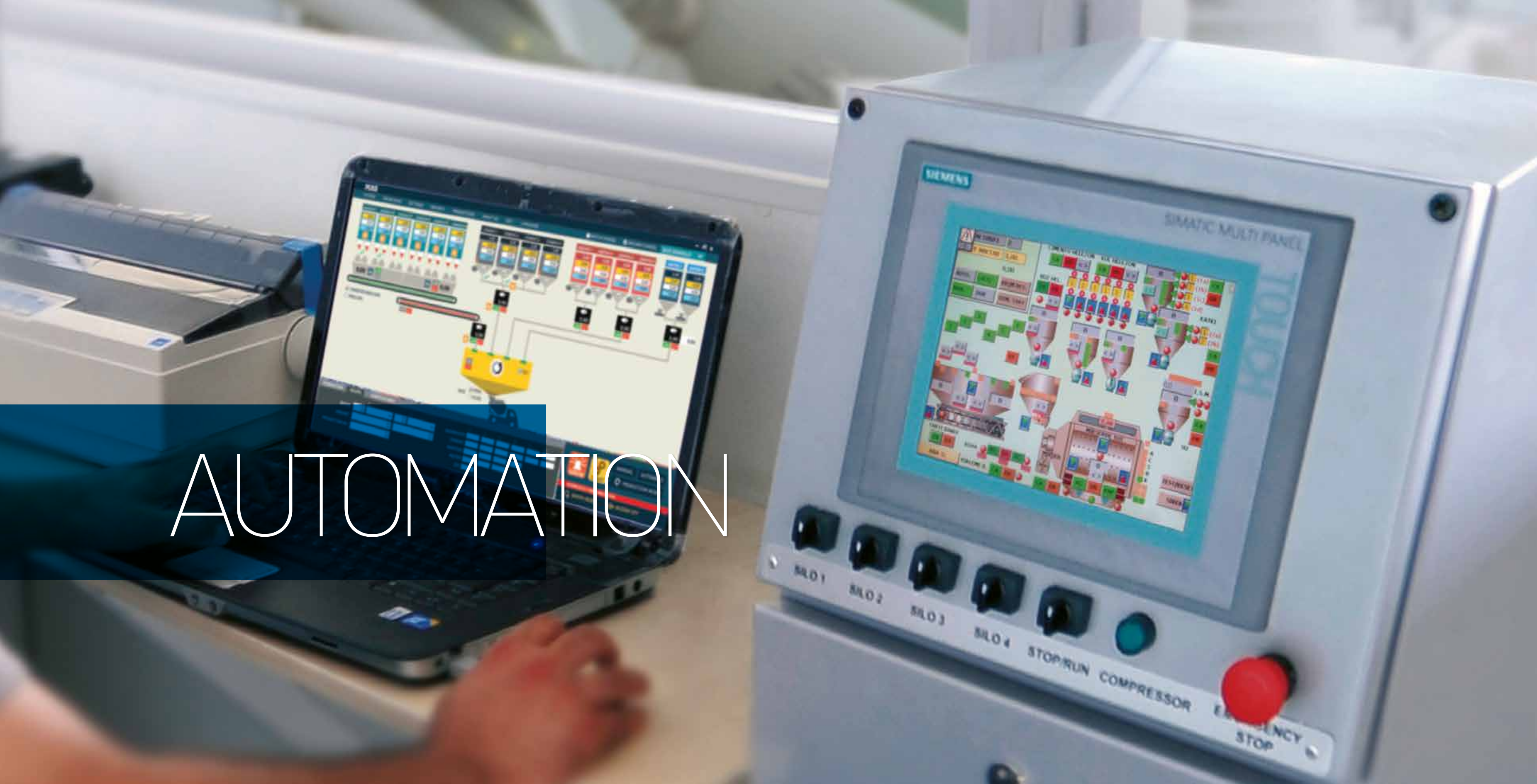



# MECAS

## Perfect Control System for every Professional

MEKA has been developing its own Software Department since more than 15 years. More than 1500 concrete batching plants operating worldwide provide an enormous feedback for the improvement. Recently this large experience has been transformed into a simple, comprehensive and extremely sensitive electromechanical structure - a MECAS Automation System.

### **Only High Quality Components**

The control panel is based on SIEMENS equipment which is available in all the parts of the world to provide the best quality and worldwide support. No manufacturer-specific hardware ensures maximum flexibility for the final customer. Main logical controller is a modular SIEMENS S7-300 PLC which is proven to be robust and reliable with wide capabilities for modification and improvement. Ethernet connection provides exceptional responsiveness and high data transfer rates. Separate touch panel allows operation without the main PC.

### **Real-time Visualization**

Main batch window resembles the actual characteristics of the concrete plant.

Comprehensive visualization is showing the actual state of the related discharge gate, scale, pump, valve or any other hardware. Moreover, the main window is customizable and can be easily adjusted to changes in the concrete batch plant configuration.

### **3 Main Operating Modes**

The system allows Fully Automatic, Semi-Automatic and Manual operating modes. Switching between modes is possible from the main batch window with a single click. The system starts in fully automatic mode by default, minor corrections and interventions can be done with the help of the buttons on scales, pumps, gates and the mixer. The system switches to semi-automatic mode automatically when operator is interfering by pressing the related buttons. In case of a need or emergency operator can completely turn off the automatic production and switch to manual mode.

### **Reach in Features**

- Multiple Language support
- Rich parameter page
- Right-Click parameter access
- Drag and Drop delivery note editor
- Automatic silo shaft
- Unlimited database
- Dynamic onscreen slump control
- Manual production/weighing reports
- Wide alarm database with explanations, guidance and codes
- Levelled authorization
- Easy adaptation with new materials
- Direct onscreen calibration
- Full discharge gate sensitivity control
- Manual moisture and absorption input
- Batch reports
- Export to Excel, automatic report saves to cloud drives
- Periodical backup
- Rich recipe control and parameters
- Detailed logbook





# SEA FREIGHT



SEA FREIGHT

# MEKA Modular Design - Container Transport Ready

*"You will not find it difficult to prove that battles, campaigns, and even wars have been won or lost primarily because of logistics." - General Dwight D. Eisenhower*

Logistics has always been a decision making factor and keeping it in mind MEKA has developed Compact and Stationary concrete batching plants with modular design to serve even the most distant markets. With our wide range of container shipment ready products nowhere is too far or too expensive to supply or purchase a proper concrete batching plant, as there is equipment that fit in standard 40FT OT containers.

#### **Sea Transportation Highlights**

Our bestseller Stationary Concrete Batching Plant MB-110K model is one of the best examples of perfect modular design. All the main components fit into 40FT OT containers.

Compact Concrete Batching Plant MB-C60 is a perfect balance between capacity, logistics, operation area and total investment. All the main components fit into 40FT OT containers.

One Stationary Concrete Batching Plant MB-30WS travelled more than 15.000km in containers to reach the distant city of Petropavlovsk-Kamchatsky to reconstruct

the aging residential areas. Despite the location where cheap products from neighboring countries are dominating a MEKA concrete plant was chosen, thanks to logistics...

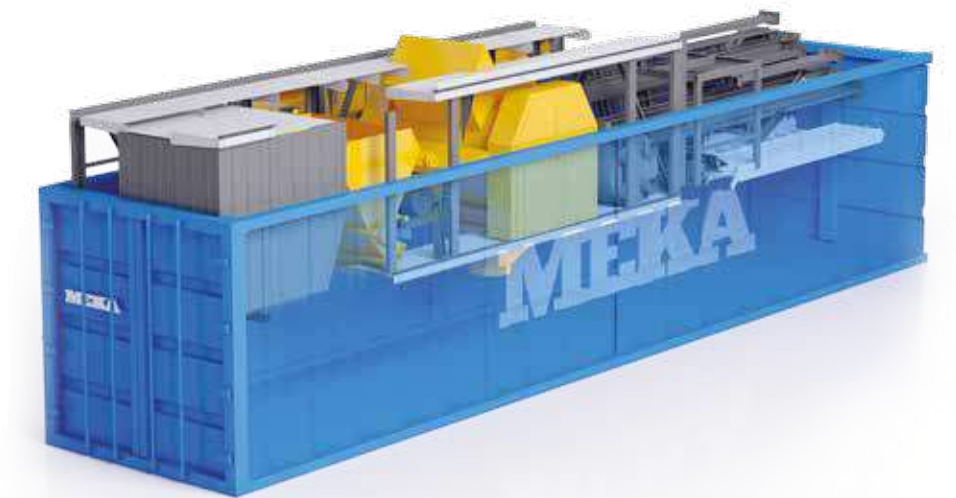



# CONCRETE MIXERS

**MERKA**  
BETON SANTRALLERİ







# Single Shaft Concrete Mixers

0,5 m<sup>3</sup> - 1,0 m<sup>3</sup> - 2,0 m<sup>3</sup>

| Technical Data               | MB-S500             | MB-S1000           | MB-S2000         |
|------------------------------|---------------------|--------------------|------------------|
| Loading Capacity             | 0,75 m <sup>3</sup> | 1,5 m <sup>3</sup> | 3 m <sup>3</sup> |
| Compacted Concrete Capacity  | 0,5 m <sup>3</sup>  | 1 m <sup>3</sup>   | 2 m <sup>3</sup> |
| Motor Output                 | 18,5 kW             | 37 kW              | 2x37 kW          |
| Side Body Wearing Plates     | 10mm ST52           | 15mm ST52          | 15mm ST52        |
| Main Body Wearing Plates     | 15mm NI-HARD        | 15mm NI-HARD       | 20mm NI-HARD     |
| Mixing Arm Wearing Plates    | 25mm NI-HARD        | 25mm NI-HARD       | 30mm NI-HARD     |
| Automatic Lubrication System | BEKA-MAX            | BEKA-MAX           | BEKA-MAX         |
| Water Distributor            | Available           | Available          | Available        |
| Pneumatic Discharge Door     | Available           | Available          | Available        |







# Twin Shaft Concrete Mixers

1,0 m<sup>3</sup> - 2,0 m<sup>3</sup> - 2,25 m<sup>3</sup> - 3,0 m<sup>3</sup> - 4,5 m<sup>3</sup> - 6,0 m<sup>3</sup>

| Technical Data               | MB-T1000           | MB-T2000         | MB-T2250            | MB-T3000           | MB-T4500            |
|------------------------------|--------------------|------------------|---------------------|--------------------|---------------------|
| Loading Capacity             | 1,5 m <sup>3</sup> | 3 m <sup>3</sup> | 3,75 m <sup>3</sup> | 4,5 m <sup>3</sup> | 6,75 m <sup>3</sup> |
| Compacted Concrete Capacity  | 1 m <sup>3</sup>   | 2 m <sup>3</sup> | 2,25 m <sup>3</sup> | 3 m <sup>3</sup>   | 4,5 m <sup>3</sup>  |
| Motor Output                 | 2x18,5 kW          | 2x37 kW          | 2x37 kW             | 2x55 kW            | 2x90 kW             |
| Gearbox                      | BONFIGLIOLI        |                  |                     |                    |                     |
| Side Body Wearing Plates     | 20mm ST52          |                  |                     |                    |                     |
| Main Body Wearing Plates     | 20mm NI-HARD 4     |                  |                     |                    |                     |
| Mixing Arm Wearing Plates    | 30mm NI-HARD 4     |                  |                     |                    |                     |
| Automatic Lubrication System | Available          |                  |                     |                    |                     |
| Hydraulic Discharge Door     | Available          |                  |                     |                    |                     |

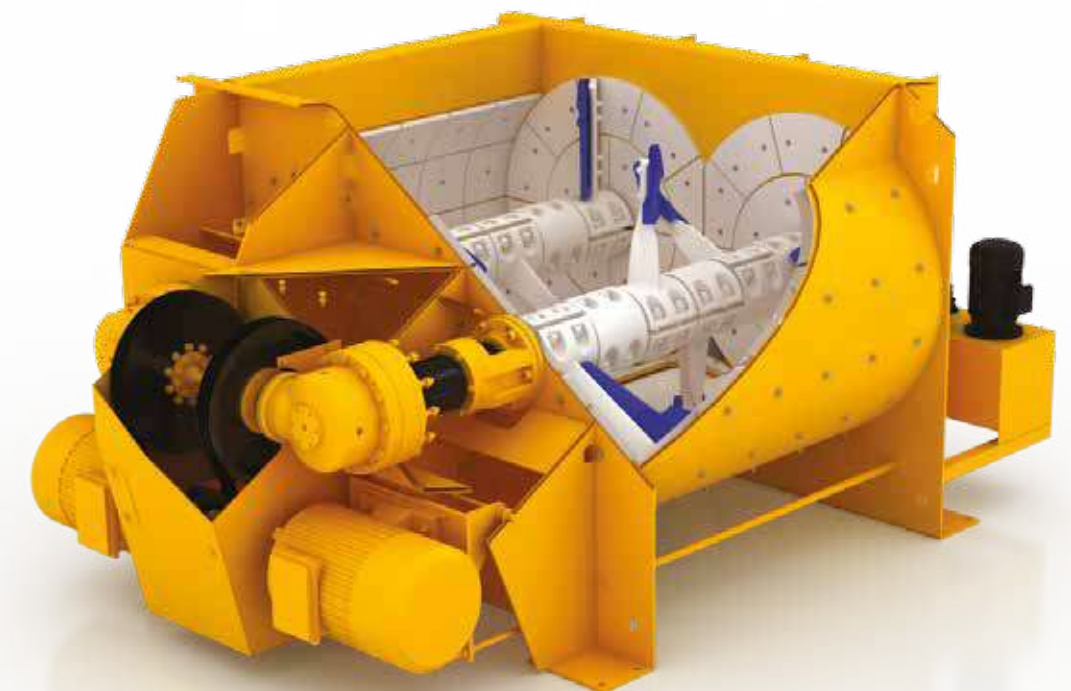





# Planetary Concrete Mixers

0,33 m<sup>3</sup> - 0,5 m<sup>3</sup> - 1,0 m<sup>3</sup> - 1,5 m<sup>3</sup> - 2,0 m<sup>3</sup>

| Technical Data                           | MB-P333             | MB-P500             | MB-P1000           | MB-P1500            | MB-P2000         |
|--|---------------------|---------------------|--------------------|---------------------|------------------|
| Loading Capacity                         | 0,5 m <sup>3</sup>  | 0,75 m <sup>3</sup> | 1,5 m <sup>3</sup> | 2,25 m <sup>3</sup> | 3 m <sup>3</sup> |
| Compacted Concrete Capacity              | 0,33 m <sup>3</sup> | 0,5 m <sup>3</sup>  | 1 m <sup>3</sup>   | 1,5 m <sup>3</sup>  | 2 m <sup>3</sup> |
| Mixer Power                              | 15 kW               | 18,5 kW             | 45 kW              | 75 kW               | 90 kW            |
| Gear Box                                 | MEKA                | MEKA                | MEKA               | MEKA                | COBRA            |
| Side Body Wearing Plates                 | 10mm ST52           |                     |                    |                     |                  |
| Bottom Wearing Plates                    | 12mm HARDOX 500     |                     |                    |                     |                  |
| Mixing Arm Wearing Plates                | 20mm NI-HARD 4      |                     |                    |                     |                  |
| No. of Stars x No. of Blade on Each Star | 1x2                 | 1x2                 | 2x2                | 2x2                 | 2x3              |
| Hydraulic Discharge Door                 | Available           |                     |                    |                     |                  |

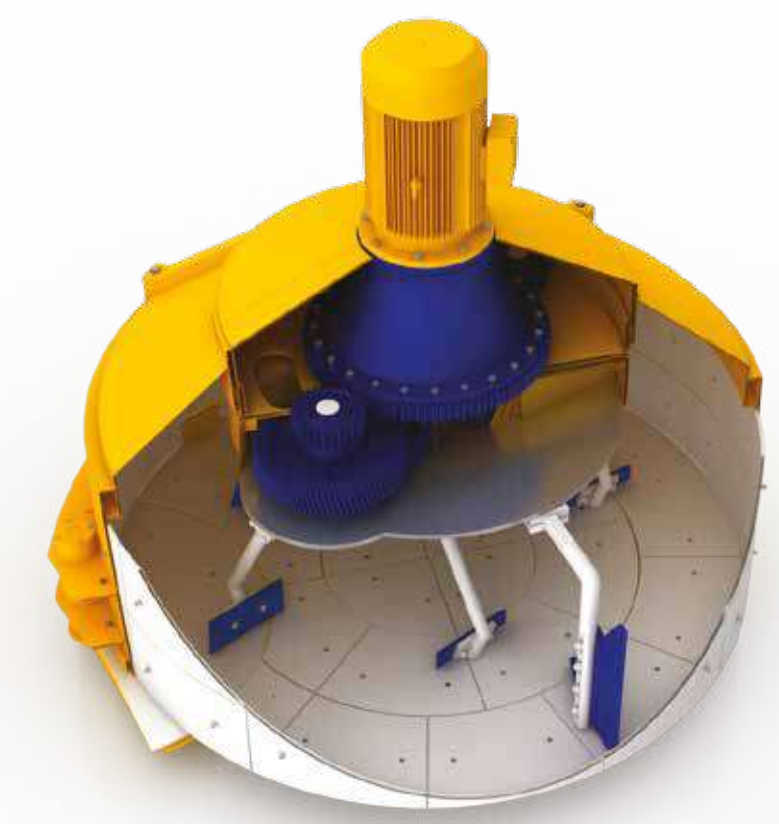





OPTIONAL  
EQUIPMENT





## OPTIONAL EQUIPMENT

# MEKA Optional Equipment

*A range of different types of additional options is available upon request.*

It includes complete cooling and heating solutions, steam/hot water suppliers and chillers, mixer washout systems, moisture probes for aggregate bins and mixers, different sensors and measurement devices, additional weighing hoppers and dosing equipment.

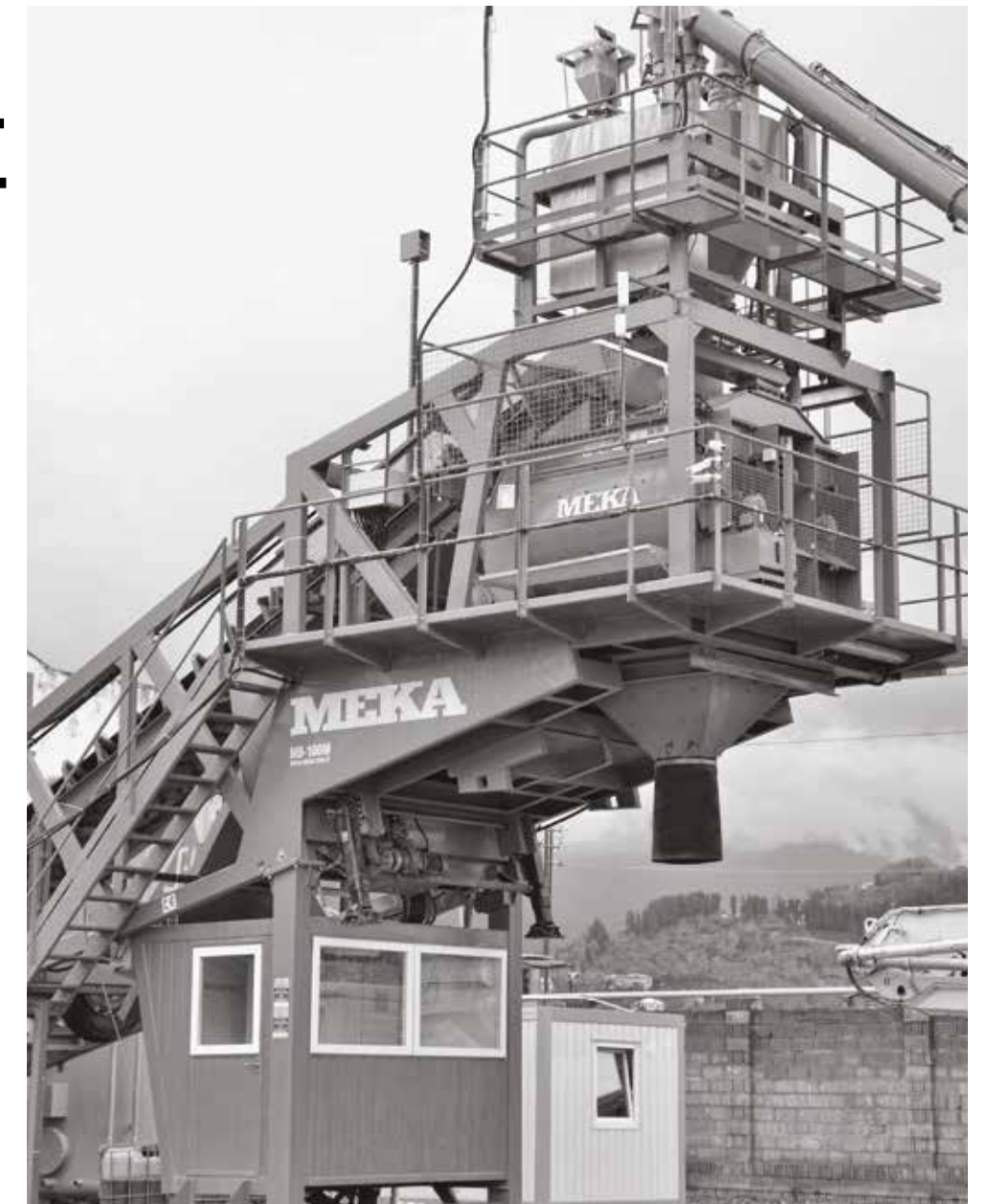





# High Pressure Washing System

|                  |  |
|------------------|--|
| Pump Motor Power | 22 kW  |
| Water flow rate  | 107 lt/min   |
| Max pressure     | 70 bar   |
| Nbr. Of Nozzles  | 2x5 pcs.   |
| Nozzle material  | INOX   |
| Water Tank       | 500 lt   |
| Accessories      | - Water Level Control Probes - 6 pcs.<br>- Water Tank inlet Filter |

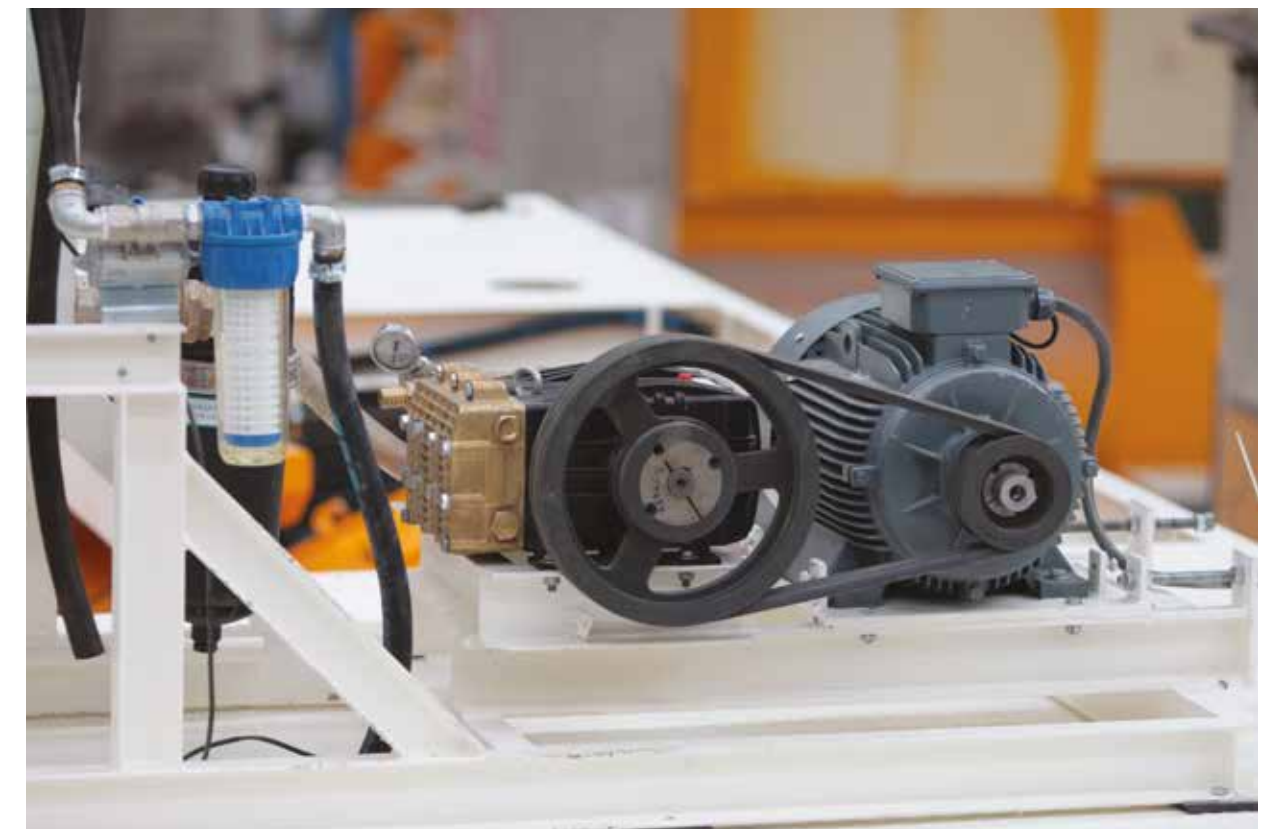





# Fiber Dosing System

## Fully Automatic Dosing Equipment For Steel & Polypropylene Fiber

The doser is filled with steel fiber from paper bags, boxes or big-bags. The desired batch, in kg, is set on a weighing instrument or in the batch plant computer. The fibers are fed on to aggregates belts, into the mixer, into the skip hoist, in the weighing bins, into the mixer discharge chute or into the truck mixer.

| Model    | A mm | B mm | C mm | D mm | E mm | Power W | Weight kg | Capacity Kg/min* | Doser Content Litre** |
|----------|------|------|------|------|------|---------|-----------|------------------|-----------------------|
| MFD 1000 | 2490 | 2170 | 1935 | 1800 | 300  | 3920    | 1200      | 40-150           | 1000                  |
| MFD 2000 | 2590 | 2370 | 2370 | 2000 | 300  | 3920    | 1450      | 40-150           | 2000                  |

\* The capacity varies depending on the type of fiber  
 \*\*Theoretical volume. The doser content in kg varies depending on type of fiber







# Recycling System

*Are you still throwing away your concrete wastes, wrong dispatches or defects?*

| Specification                              | Value                             |
|--|-----------------------------------|
| Capacity                                   | Discharging of 1 Vehicle Capacity |
| Recycling Capacity                         | 15 m <sup>3</sup> /h              |
| Loading Hopper Dimension                   | 730x1200 mm                       |
| Height of Loading                          | 1670 mm                           |
| Height of Discharge                        | 2032 mm                           |
| Length of Separator screw conveyor         | 5000 with hopper                  |
| Screw Conveyor Motor Gear-Box Power        | 5.5 kW                            |
| Screw Conveyor Washing Pump Power          | 2.2 kW                            |
| Screw Conveyor Washing Pump Capacity       | Height 10 m, 37 m <sup>3</sup> /h |
| Recycling Pump Power                       | 7.5 kW                            |
| Recycling Pump Capacity                    | Height 30 m, 30 m <sup>3</sup> /h |
| Agitator Power                             | 5.5 kW                            |
| Agitator Speed                             | 52 rpm                            |
| Agitator Diameter                          | 1.2 m                             |
| Submersible Pump Maintenance Reel Capacity | 1000 Kg                           |
| Flowing Pipe for Recycling Water           | AVAILABLE                         |
| Discharge Channel                          | AVAILABLE                         |
| Intake Reservoir                           | AVAILABLE                         |



# ADDITIONAL OPTIONS





# Improve the Capabilities and Characteristics of your MEKA Concrete Plant



## 1. Additional Weighing/Dosing

Different concrete types and characteristics can be achieved with a variety of additives, powders, fibers and many other options. MEKA offers additional weighing equipment for automatic manufacturing.

- Microsilica weighing hoppers (dry or slurry)
- Ice weighing hoppers and screw conveyors
- Flowmeters for water and additives for exact or tempered weighing
- Additional Cement/Fly Ash/Lime/GGBS weighing hoppers
- Pigment (dry paint) dosing systems
- Automatic fiber dosing systems for soft or steel/polypropylene fiber
- Lead ball weighing and feeding system (for extra heavy concrete types)

## 2. Measurement and Monitoring

Additional measurement and monitoring equipment allows full control of the mixtures consistency and temperature, stock level and other important characteristics.

- Mixer moisture probe and flowmeter for water/cement ratio correction
- Mixer Temperature monitor
- Mixer slump reader
- Silo level control accessories (Radar/

Ultrasonic measurement)

-Cement and Water Temperature monitor

## 3. Operational Options

MEKA operational options are designed for ease and safety of the operation along with extra useful features.

- Two discharge legs (for some models)
- Wet, Half Wet & Dry Options (for some models)
- Swivel Chute to prevent concrete leak on the trucks
- Moving discharge chutes for different operations
- High Pressure Mixer Washout System
- Filter over the mixer for dust suppression
- BIG-BAG cement transfer system

## 4. Winter and Other climatic options

MEKA concrete plants can be operated in different climate conditions. We offer both cooling and heating systems.

- Steam (closed/open cycle), hot water or hot air suppliers for aggregate bins
- Cladding with sandwich panels or corrugated steel panels
- Steam/Hot water generators
- Covers over the aggregate bins
- Chillers

## 5. Extra Health and Safety Features

Take care of your people on the highest level. Ask for additional health and safety options.

- Isolation of moving parts
- Pinch valves
- Safety locking systems
- Silo pressure sensors and alarms



# MEKA

**Crushing and Concrete Batching Technologies**

**[www.mekacrushers.com](http://www.mekacrushers.com)**

**[www.mekaconcreteplants.com](http://www.mekaconcreteplants.com)**

## HEAD OFFICE

Çamlıca Mh. Anadolu Bl. 147. Sokak.  
Atlas İş Merkezi No:5/9,  
06200 Gimat, ANKARA / TURKEY  
Tel :+90 312 397 91 33 (pbx)  
Fax :+90 312 397 10 34  
E-mail :sales@meke.com.tr

## SERVICE CENTER

Ostim Sanayi Sitesi 56. Sokak. No:26-28  
06370 Ostim, ANKARA / TURKEY  
Tel :+90 312 385 52 55 (pbx)  
Fax :+90 312 385 10 27

**TURQUM**  
THE QUALITY OF TURKISH MACHINERY

